

EN

**OPERATING
INSTRUCTIONS
DISHWASHER
HUI6220XCUS**

Hisense

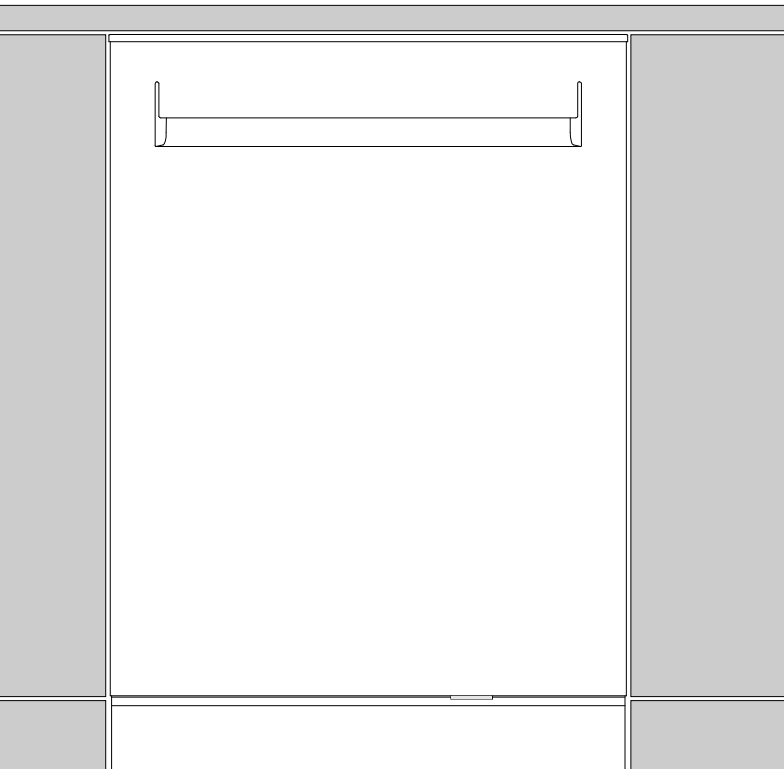

Contents

| | |
|---|----|
| Your dishwasher | 2 |
| Important safety instructions | 3 |
| Before washing for the first time | 4 |
| Loading the dishwasher | 5 |
| Using the dishwasher | 7 |
| Settings | 12 |
| Care and maintenance instructions | 13 |
| Troubleshooting | 15 |
| Installation instructions | 19 |
| Service | 22 |
| Technical information | 23 |

Your dishwasher

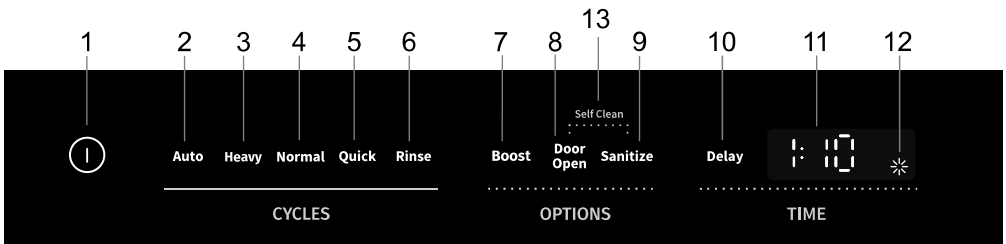

- | | |
|----------------------|-------------------------|
| 1. Main power switch | 8. Door Open |
| 2. Auto | 9. Sanitize |
| 3. Heavy | 10. Delay |
| 4. Normal | 11. Display |
| 5. Quick | 12. Rinse aid indicator |
| 6. Rinse | 13. Self Clean |
| 7. Boost | |

Important safety instructions

SAVE THESE INSTRUCTIONS FOR FUTURE REFERENCE

WARNING!

When using your dishwasher, follow basic precautions, including the following:

- Read all instructions before using the dishwasher.
- Use the dishwasher only for its intended function.
- Use only detergents or wetting agents recommended for use in a dishwasher and keep them out of the reach of children.
- When loading items to be washed:
 - locate sharp items so that they are not likely to damage the door seal, and
 - load sharp knives with the handles up to reduce the risk of cut-type injuries.
- Do not wash plastic items unless they are marked “dishwasher safe” or the equivalent. For plastic items not so marked, check the manufacturer’s recommendations.
- Do not operate the dishwasher unless all enclosure panels are properly in place.
- Do not tamper with controls.
- Do not abuse, sit on, or stand on the door or dish rack of the dishwasher.
- To reduce the risk of injury, do not allow children to play in or on a dishwasher.
- Under certain conditions, hydrogen gas may be produced in a hot water system that has not been used for two weeks or more. HYDROGEN GAS IS EXPLOSIVE. If the hot water system has not been used for two weeks, before using the dishwasher turn on all hot water faucets and let the water flow from each for several minutes. This will release any accumulated hydrogen gas. As the gas is flammable, do not smoke or use an open flame during this time.
- Remove the door to the washing compartment when removing an old dishwasher from service or discarding it.
- Read the grounding instructions in the installation instructions.

General

- Do not run the dishwasher while you are out of the home.
- Do not store or use combustible materials, gasoline, or other flammable vapors and liquids in the vicinity of this or any other appliance.
- Disconnect electrical power to dishwasher before servicing.
- Repairs should be done by a qualified technician.

NSF/ANSI 184 certified residential dishwashers are not intended for licensed food establishments.

WARNING!

Only sanitizing cycles have been designed to meet the requirements of NSF/ANSI 184 for soil removal and sanitization efficacy. There is no intention, either directly or indirectly, that all cycles on a certified machine have passed the sanitization performance test.

WARNING!

PROPOSITION 65 FOR CALIFORNIA RESIDENTS

Cancer and Reproductive Harm – www.P65Warnings.ca.gov

Installation

See the chapter Installation instructions.

Child safety

TIP!

Dishwasher detergents and rinse aids are corrosive, so always keep them out of reach of children.

- Should a child swallow dishwasher detergent or rinse aid, give plenty to drink immediately, i.e., one or two glasses of milk or water. Do not try to induce vomiting. Seek medical advice immediately: Call the National Capital Poison Center at 1-800-222-1222.
- Always close the door and start the dishwasher as soon as you put in the detergent.
- Always keep small children away from the machine when it is open. There may be some detergent residue left inside the machine.
- If dishwasher detergent gets in someone’s eyes, rinse them with plenty of water for at least 15 minutes.

Winter storage/transport

Store the dishwasher above freezing and avoid long transport distances in very cold weather. Transport the dishwasher upright or laying on its back.

Overflow guard function

The overflow protection starts pumping out the machine and turns off the water supply if the water level in the dishwasher exceeds the normal level. If the overflow protection is triggered, turn off the water supply and call the Customer Care Center.

Packing material

The packaging protects the product during transport. The packaging material is recyclable. Separate the different packaging materials to help reduce raw material use and

waste. Your dealer can take the packaging for recycling or direct you to the nearest recycling center. The packaging is comprised of:

- Corrugated cardboard made from up to 100% recycled material.
- Expanded polystyrene (EPS) with no added chlorine or fluorine.
- Supports made from untreated wood.
- Protective plastic made from polyethylene (PE).

Disposal

The dishwasher is manufactured and labeled for recycling.

When the machine has reached the end of its service life and is to be disposed of, it should immediately be made unusable. Pull out the power cable and cut it as short as possible.

Contact your municipality for information about where and how your dishwasher can be recycled correctly.

Checking water hardness

Contact the local water utility to check the water hardness in your area. This is important to determine how much detergent and rinse aid to use.

In general, more rinse aid and detergent are needed for hard water.

Set the Rinse aid

The chapter Settings describes how to set the rinse aid dosage.

Top up with rinse aid

Use rinse aid to improve wash and dry times. Also use rinse aid to achieve clear and spotless results.

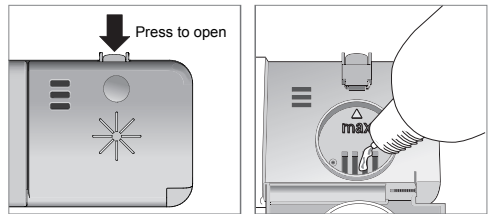

1. Open the rinse aid compartment lid.
2. Carefully top up with rinse aid to the level marked **max**.
3. Wipe up any spilled rinse aid around the compartment.
4. Close the lid firmly.

Loading the dishwasher

Greener dishwashing

- Do not rinse under running water. Simply scrape off large food particles before loading the dishwasher.
- Choose an environmentally-friendly detergent. Read the environmental declaration on the packaging!
- Do not start the dishwasher until it is fully loaded to save energy.
- If the dishes are only lightly soiled, you can select a program with a low temperature.
- Better drying results are achieved if you use the Door Open option, which automatically opens the dishwasher door. Wait until the dishwasher indicates that the program has ended and the dishes have cooled before unloading the dishwasher. (If the dishwasher is built-in, the surrounding furnishings must be resistant to any condensation from the dishwasher.)

Fragile dishes

Some cookware is not dishwasher safe. This can be for several reasons. Some materials cannot withstand high temperatures, others can be damaged by dishwasher detergent.

Use caution with, for example, handmade items, fragile decoration, crystal/glassware, silver, copper, tin, aluminum, wood, and plastic. Look for the "Dishwasher safe" marking.

Points to consider

- All dirty surfaces should face in and down!
- Dishes should not be placed in or on each other.
- Angle dishes with hollows, such as cups, so that the rinse water will run off. This is also important for plastic items.
- Place the upper basket in its highest position when dishwashing very large plates.
- Make sure small items cannot fall through the dishwasher basket; place them in the cutlery basket.

wine glasses on the wine glass shelf. Place knives in the knife stand on the right (if space allows).

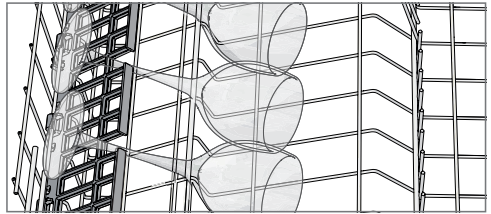
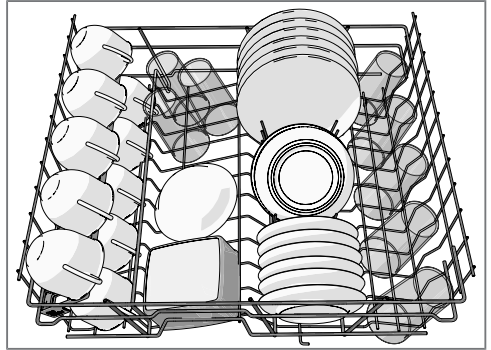

Raising and lowering the upper basket

1. Pull out the upper basket.
2. Grab the sides of the upper basket with both hands and lift it up.
3. Repeatedly lift the basket with both hands to change its position. (The upper basket can be set in three positions.) When the upper basket is in the highest position, lifting it will return it to the lowest position. Note that both sides of the basket must always be set to the same height.

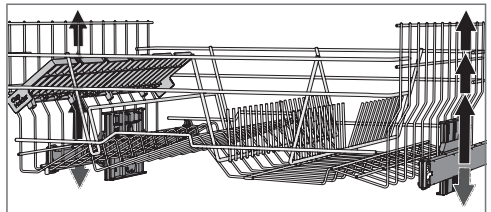

NOTE!

Check that the spray arms can rotate freely.

The baskets

The dishwasher includes an upper, a lower, and a cutlery basket.

The basket appearance may differ depending on the configuration.

Upper basket

Place glasses, cups, bowls, side plates, and saucers in the upper basket. Place all soiled surfaces face down! Place

Lower basket

Place plates, side plates, serving dishes, pots, and cutlery (in the cutlery basket) in the lower basket.

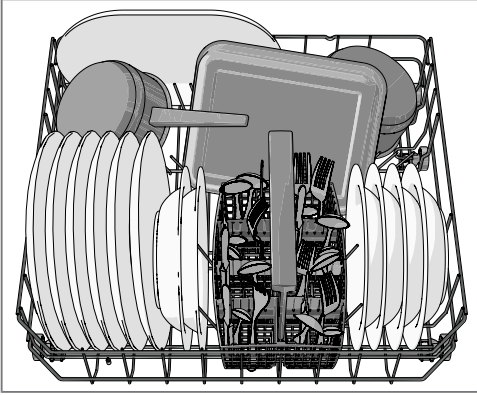

Typical load

Recommended for daily, regular, or typical use.

Upper basket

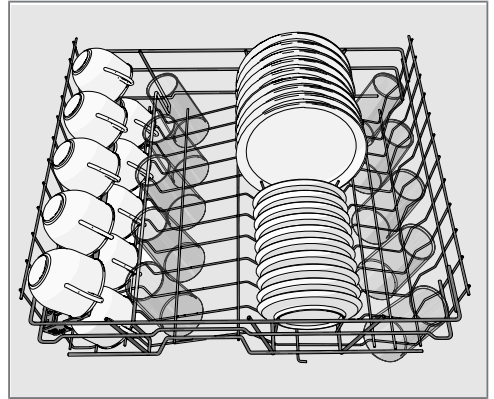

Cutlery basket

Place cutlery with the handles facing down, except for knives, and spread them out as much as possible. Ensure that spoons do not stack inside each other.

Place the cutlery basket in the lower basket.

Cutlery basket with lid

The cutlery basket lid can be removed.

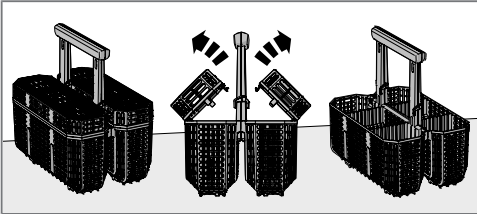

Flexible cutlery basket

The cutlery basket is flexible and can be separated into two parts, which can then be attached to the side of the lower basket.

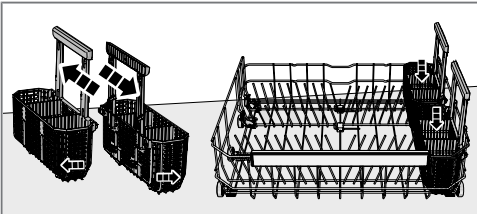

NOTE!

Ensure the upper basket is set to its lowest position.

Lower basket

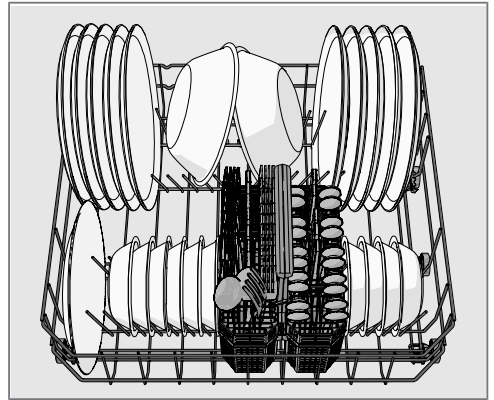

Add detergent

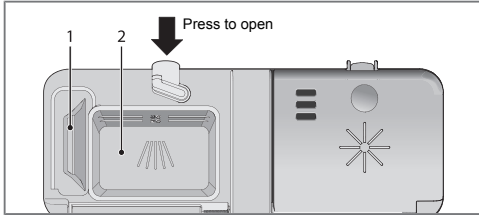

1. Prewash detergent compartment
2. Main wash detergent compartment

Detergent is added according to water hardness.

Follow the instructions on the detergent packaging.

Too much detergent can result in less effective dishwashing and also entails greater environmental impact.

The detergent compartment must be dry when adding detergent. There is one compartment for the prewash and one for the main wash. If powder or liquid dishwasher detergent is used, add a small amount of the detergent to the prewash compartment. Contact the detergent manufacturer if you have questions about the detergent.

NOTE!

Use only dishwasher detergent! Liquid hand-washing detergent must not be used as the foam that forms prevents the dishwasher from operating effectively.

Dishwasher tablets

Halve the tablet if it is difficult to close the dispenser lid. There is a risk that the detergent will not be released properly if the lid is tight and cannot open correctly.

NOTE!

Dishwasher tablets are not recommended for short programs (less than 75 minutes). Use powder or liquid dishwasher detergent instead.

All-in-one detergent

There are many types of all-in-one detergents on the market. Read through the directions for these products carefully.

If the detergent tablets contain rinse aid, the dishwasher's rinse aid dosing can be deactivated. See the chapter Settings.

NOTE!

Optimal washing and drying results are achieved by using normal dishwasher detergent together with separately dispensed rinse aid.

Open the door and press the main power switch.

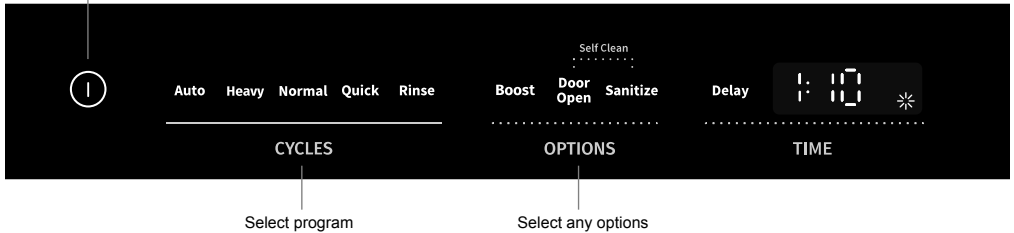

To start the program: Press and hold the desired program until the program symbol starts to flash.
Close the door within four seconds to start the dishwasher.

The main power switch

Press and hold the main power switch until the display turns on. Also check that the water supply valve is on.

CYCLES - Select a program

Select a program to suit the type of dishes and how dirty they are.

Press the desired program until the program symbol is activated.

Auto

The dishwasher can measure how dirty the dishes are and adjust water consumption and temperature accordingly. When newly installed, the program needs to be run five times before it is fully adapted and can provide the best results.

Auto¹⁾ + Boost + Door Open

An effective program for daily use with slightly dried leftovers. (This program is not intended for burnt food, such as on oven dishes.)

Heavy

Program for heavily soiled dishes, such as pans, casserole dishes, and oven dishes. If these dishes do not completely fill the dishwasher, you can add plates and other dishes that can withstand a Heavy wash to fill out the load.

Combine the Heavy program with the Sanitize option to meet the performance requirements of the NSF/ANSI 184 standard.

Normal

This program is recommended for daily, regular, or typical use to completely wash a full load of normally soiled dishes, such as plates, serving dishes, cups, and glasses.

Quick

This program is used for glasses and porcelain that is lightly soiled, such as coffee cups.

In combination with Boost, a shorter program is achieved (15 minutes).

Rinse

Use to rinse dishes while you wait for the dishwasher to become fully loaded.

OPTIONS - Select an option

To select an option, press one of the option buttons until the option is activated. The available options vary between programs and some options cannot be combined (available options glow dimly).

Boost

This option shortens the program time, but uses more energy and water.

Door Open

The dishwasher door opens automatically, which improves the drying results. Wait until the dishwasher indicates that the program has ended and the dishes have cooled before unloading the dishwasher. (If the dishwasher is built-in, the surrounding furnishings must be resistant to any condensation from the dishwasher.)

NOTE!

The dishwasher door must not be blocked when set to open automatically. This can disrupt door lock functionality.

Sanitize

This option is intended for items with particularly high sanitation requirements, such as baby bottles and cutting boards.

¹⁾ This combination (Auto + Boost + Door Open) is also known as QuickIntensive (90 minutes).

The temperature is increased in both the main wash and the final rinse.

Sanitize has been developed to be combined with the Heavy dishwashing program. The program meets the requirements of the NSF/ANSI 184 standard.

NOTE!

If the program is run in compliance with the NSF/ANSI 184 standard, "End" is shown on the display and the Sanitize option button lights when the program has finished.

Delay

When you select Delay, the dishwasher will start 1-24 hours after you close the door.

1. Press the button once to activate Delay. Press the button several times – or hold it in – to set the desired number of hours.
2. Close the door and the dishwasher display counts down 1 hour at a time and starts after the selected delay.

If you want to cancel the Delay option, open the door and press and hold the main power switch until the display turns off.

Starting the dishwasher

1. To activate a program and an option: Press the desired program and then the desired option.
2. To start the program: Press and hold the desired program until the program symbol starts to flash.
3. Close the door within four seconds to start the dishwasher.

TIME - Time remaining

Once you have chosen a program and options, the time the program took when last used is displayed.

Stopping or changing a program

If you want to change the program after starting the dishwasher, open the door then press and hold the main power switch until the display turns off. Add more detergent if the lid of the detergent dispenser has opened. Then press the main power switch again to choose a new program.

⚠ WARNING!

"STR" is shown on the display if the dishwasher door is opened while a program is in progress. If you want the dishwashing program to continue, press the flashing program button and close the door immediately. (For Self Clean, press the associated option buttons.) If you want to cancel the dishwashing program, press and hold the main power switch until the display turns off.

If the dishwasher is turned off due to a power failure

If the program was not finished, the interrupted program resumes when power is restored.

NOTE!

During drying, the program is interrupted if the power is cut or the door is open for more than 2 minutes.

Once the program has finished

The end of the program is indicated by one short signal from the buzzer. The chapter Settings describes how to change this function.

The dishwasher switches off automatically after the program ends.

To minimize the risk of leaks, we recommend that you turn off the water supply valve if away from home for an extended period of time.

How to get the best drying results

- Fully load the dishwasher.
- Angle dishes with hollows, such as cups, so that the rinse water will run off. This is also important for plastic items.
- Top up with rinse aid or increase the rinse aid dosage level.
- Activate the Door Open option.
- Allow the dishes to cool before unloading the dishwasher.

Unloading the dishwasher

Hot porcelain is more fragile. Leave the dishes to cool in the dishwasher before unloading them.

Unload the lower basket first to avoid any water drops from the upper basket falling onto the dishes in the lower basket.

Special programs

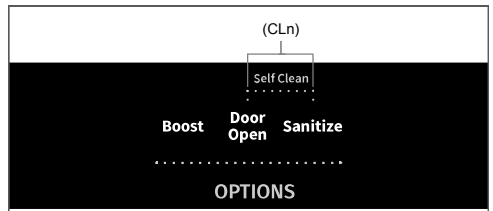

Press and hold the associated option buttons to activate a special program. The program starts when the door is closed.

Self Clean (CLn)

Self-cleaning program for sanitizing the dishwasher tub, spray arms, and spray pipes.

This program should be run (with no dishes in the machine) using regular dishwasher detergent or citric acid. Special dishwasher cleaners are also available in stores. For the removal of limescale deposits, see The dishwasher tub in the chapter Care and maintenance instructions.

Program chart

| CYCLES - Program | Detergent, compartment 1 / 2 (ml) | OPTIONS - Options | Prewashes | Main wash | Number of rinses | Final rinse | Consumption values ¹⁾ | | |
|----------------------|--|----------------------|-----------|------------------------|---------------------|------------------|---|-------------------------|---------------------------------------|
| | | | | | | | Dishwashing time (approx. hrs:min) | Energy (approx. kWh) | Water cons. (gallon) ²⁾ |
| Auto | --- / 25 | Door Open | 2-3 | 50-65 °C 120-150 °F | 2-3 | 65 °C 150 °F | 2:40-3:15 | 1.0-1.6 | 3.7-5.3 |
| Heavy | 10 / 25 | | 2 | 70 °C 160 °F | 2 | 65 °C 150 °F | 3:25 | 1.7 | 4.5 |
| Normal ³⁾ | --- / 25 | Door Open | 3 | 50 °C 120 °F | 2 | 65 °C 150 °F | 2:15 | 1.20 | 3.49 |
| Quick | --- / 10 | | | 35 °C 95 °F | 1 | 25 °C 80 °F | 0:20 | 0.2 | 2.6 |
| Rinse | --- / --- | | | | 1 | --- °C --- °F | 0:07 | 0.01 | 0.8 |

1) Consumption values vary depending on the temperature of the incoming water, room temperature, load size, selected additional functions, and more.

2) Connection to cold water, approx. 50 °F (10 °C). (A cold water supply is recommended.)

3) The energy label performance figures are based on this program. This program is recommended for daily, regular, or typical use to completely wash a full load of normally soiled dishes, such as plates, serving dishes, cups and glasses.

Settings

Open the settings menu:

1. First, open the door. Turn off the machine. Press and hold the main power switch until the display lights up.
2. Within 10 seconds:
 - press the program button for Auto and the option button for Boost.
3. The display shows the settings menu (current setting and its currently set value).
(Exit the menu by browsing through the menu or pressing the main power switch.)

Navigate the settings menu:

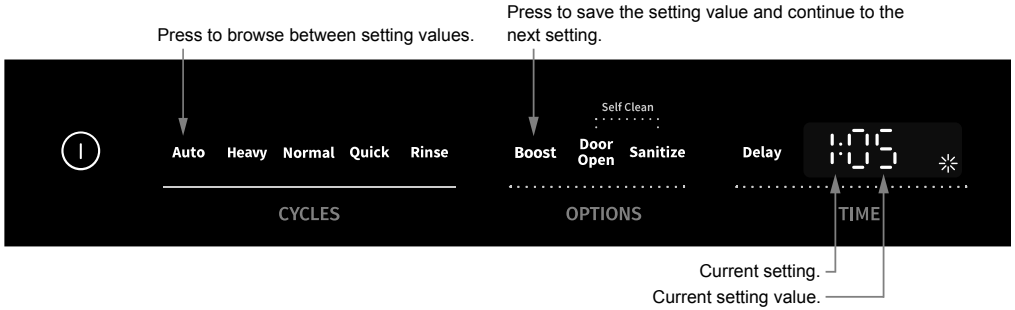

You can now adjust the following settings:

| Settings | | Options | |
|----------|----------------------|-------------|---|
| 1. | Rinse aid | 1:00 - 1:05 | Rinse aid dosage setting. Increase the rinse aid dosage: <ul style="list-style-type: none"> • If the dishes have water marks. Reduce the rinse aid dosage: <ul style="list-style-type: none"> • If the dishes have a sticky white/blue film. • If the dishes are streaked. • Heavy foaming. If you have very soft water, the rinse aid can be diluted 50:50 with water. <i>Pre-selected at factory: 05</i> |
| 2. | Buzzer volume | 4:00 - 4:03 | The dishwasher uses a buzzer to indicate when a program is finished or when a fault has occurred. |

Care and maintenance instructions

Top up with rinse aid

When the rinse aid needs topping up, the above symbol lights on the display.

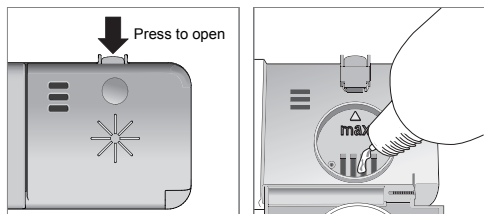

1. Open the rinse aid compartment lid.
2. Carefully top up with rinse aid to the level marked **max**.
3. Wipe up any spilled rinse aid around the compartment.
4. Close the lid firmly.

After topping up, it may take a while before the symbol goes out.

Coarse filter

The coarse filter traps larger food particles, which cannot get past the drain pump. Empty the coarse filter when necessary.

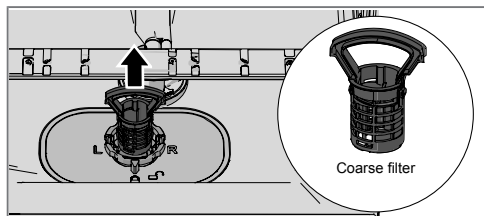

1. Lift the coarse filter by the handle.
2. Empty the coarse filter.
3. Refit the coarse filter. Press it down until it clicks into place.

Fine filter

Debris that collects on the fine filter is automatically rinsed away during each wash. Clean the fine filter when necessary. It should be cleaned at regular intervals depending on how often the dishwasher is used.

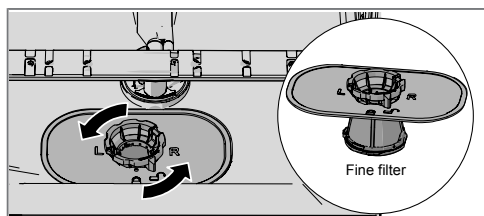

1. Turn the locking ring counterclockwise and lift the fine filter straight up.
2. Clean the fine filter.
3. Refit the fine filter and turn the locking ring clockwise to its stop position. Check that the edges seal properly. Remember to refit the coarse filter!

NOTE!

Dishwashing results may be affected if the coarse and fine filters are incorrectly fitted. The dishwasher must not be used without the filters in place!

NOTE!

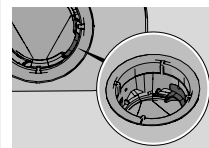

Check that the colored stop on the right in the bottom drain is in place.

Spray arms

Holes and bearings can become blocked. Remove debris using a needle or similar item. The spray arms have holes on the bottom.

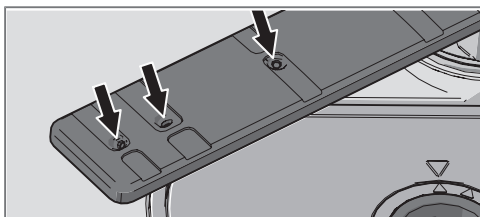

Spray arms can be removed for cleaning. Remember to fit them firmly back into place afterward.

Lower spray arm

- Pull the lower spray arm straight up to release it.

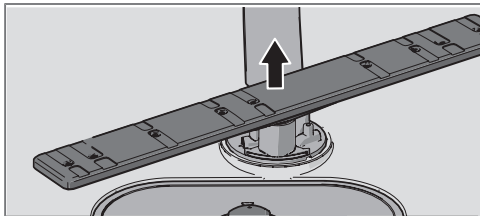

Upper spray arm

1. Pull out the upper basket.

2. Unscrew the spray arm bearings counterclockwise to remove the spray arm from the upper basket.

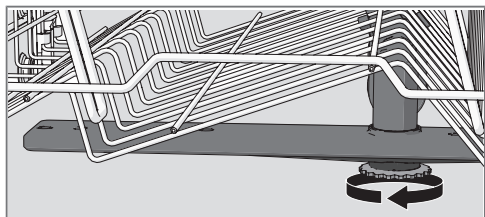

The door and the door seal

Regularly clean the sides of the door and the door seal. Use a slightly damp cloth (with a little cleaner if necessary).

Display panel

Keep the buttons clean and free from grease. Wipe them clean with a dry or slightly damp cloth. Never use cleaners – they can scratch the surface. Use the main power switch to turn off the dishwasher before cleaning the buttons to avoid activating any buttons unintentionally.

The dishwasher tub

The dishwasher tub is made of stainless steel and is kept clean through normal use.

Limescale deposits

If you have hard water, limescale deposits may build up in the dishwasher. If this happens, run a self-cleaning program with two tablespoons of citric acid in the detergent compartment (with no dishes in the machine). See Self Clean in the chapter Using the dishwasher.

Unblocking the drain pump

If the dishwasher still contains water after the program has finished, something may be blocking the drain pump. Such items are easily removed.

1. Turn off the machine using the main power switch and unplug it from the power outlet.
2. Remove the coarse filter and the fine filter.
3. Scoop out the water from the dishwasher tub.
4. In order to inspect the drain pump, remove the colored stop on the right in the bottom drain.
5. Turn the pump wheel located behind the drain pump stop by hand. Carefully remove any items.
6. Reinstall the drain pump stop along with the fine and coarse filters.
7. Plug the machine in again.

If the dishwasher still does not start and a whirring sound is heard, the overflow protection has been triggered.

- Shut off the water.
- Unplug the unit from the power outlet.
- Call the Customer Care Center.

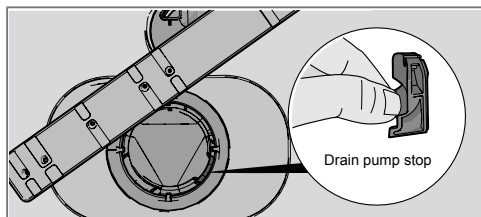

NOTE!

Do not forget to reinstall the drain pump stop.

TIP!

Use citric acid or commercially available dishwasher cleaner.

Troubleshooting

| Type of fault on the display | | Action |
|------------------------------|---------------------|---|
| F10 | Overfilling | Clear the drain pump. See the chapter Care and maintenance instructions. If the problem persists, call the Customer Care Center. |
| F11 | Water outlet fault | See "Water remains in the dishwasher above the filters" in the table "Problem" below. If the problem persists, call the Customer Care Center. |
| F12 | Water inlet fault | Check that the water supply valve is on. If the problem persists, call the Customer Care Center. |
| F40 | Inlet valve leakage | Turn off the water supply valve and call the Customer Care Center. |
| F52 | Water level fault | Clean the coarse and fine filters. If the problem persists, call the Customer Care Center. |
| F54 | Overfilling | Turn off the water supply valve and call the Customer Care Center. |
| F56 | Circulation fault | Call the Customer Care Center. |

Press any button to clear the error message.

| Problem | Possible causes | Action |
|--|---|---|
| The buttons do not react when pressed. | You have pressed the buttons too soon after opening the door. | Wait a moment then try again. |
| | The buttons are dirty. | Clean with a dry or slightly damp cloth. |
| | The door is closed. | Open the door. The buttons only react to use when the door is open. |
| Cannot close door. | The baskets are not correctly positioned. | Check that the baskets are correctly positioned horizontally. |
| | | Check that the dishes are not blocking the baskets from sliding properly into place. |
| | The door lock does not click into place and lock. | Check the door lock. If it does not click into place, open the door. Press and hold the button for the Door Open option for 15 seconds. Then wait 30 seconds. Close the door. Check that the door lock clicks into place. |

| Problem | Possible causes | Action |
|--------------------------------|--|--|
| The dishwasher does not start. | The door is not closed properly or was not closed immediately after starting the program. | Close the door within four seconds, otherwise the dishwasher will not start. See Starting the dishwasher in the chapter Using the dishwasher. |
| | The door lock has not clicked into place and locked. | Check the door lock. If it has not clicked into place, open the door. Press and hold the button for the Door Open option for 15 seconds. Then wait 30 seconds. Close the door. Check that the door lock clicks into place. |
| | A fuse/circuit breaker has been tripped. | Check. |
| | The plug is not plugged into the power outlet. | Check. |
| | The water supply valve is turned off. | Check. |
| | Overflow/leaks. | Check. |
| | A whirring sound (the drain pump) is heard from the dishwasher and does not stop when the main power switch is turned off. | Turn off the water supply valve. Pull out the plug and call the Customer Care Center. |
| | Check that the Delay option has not been selected. | Press and hold the main power switch until the display turns off if you want to cancel the Delay option. Restart the dishwasher. |
| The dishes are not clean. | The spray arms do not rotate. | Remove the arms and clean them. |
| | | Check that the dishes are not blocking the spray arms. |
| | Spray arm holes or bearings blocked. | Clean the spray arms. See the chapter Care and maintenance instructions. |
| | Unsuitable dishwashing program. | Choose a longer program. |
| | Incorrect detergent dosage. | Dose according to water hardness. Far too much or far too little detergent can result in poor dishwashing results. |
| | Detergent is too old. Detergent is a perishable product. | Avoid large packages. |
| | Dishes loaded incorrectly. | Do not cover dishes with large bowls or lids. Avoid placing very tall glasses in the corners of the baskets. |
| | Glasses and cups have toppled over during the program. | Load the dishes securely. |
| | The filters are not fitted correctly. | Check that the filter handle is locked in the stop position. |
| Drain pump stop missing. | Check that the colored stop on the right in the bottom drain is in place. See the chapter Care and maintenance instructions. | |

| Problem | Possible causes | Action |
|--|---|---|
| Spots on stainless steel or silver. | Some types of food, such as mustard, mayonnaise, lemon, vinegar, salt, and dressings, can cause spots on stainless steel if left for too long. | Rinse off these types of food if not starting the dishwasher immediately. Use the Rinse program. |
| | All stainless steel can cause spots on silver if they come into contact during dishwashing. Aluminum can also cause spots on dishes. | In order to avoid marks and tarnishing, separate dishes made from different metals, such as silver, stainless steel, and aluminum. |
| Spots or films on the dishes. | Incorrect rinse aid dosage setting. | See the chapter Settings. |
| | Too high temperature and/or too much detergent can cause etching on crystal. Unfortunately, this cannot be repaired, only prevented. | Wash crystal at a low temperature and with a conservative amount of detergent. Contact the detergent manufacturer. |
| The dishes have a sticky white/blue film. | Rinse aid dosage setting too high. | Reduce the amount. See the sections Before washing for the first time and Settings. If you have very soft water, you may want to dilute the rinse aid 50:50 with water. |
| Spots left after washing. | Lipstick and tea can be difficult to wash off. | Use a detergent with a bleaching agent. |
| Detergent residue in the detergent compartment after dishwashing. | The detergent compartment was damp when adding detergent. | The detergent compartment must be dry when adding detergent. |
| Rattling sound when dishwashing. | The dishes are not correctly placed or the spray arms are not rotating. | Check that the dishes are placed securely. Spin the spray arms to make sure they can rotate. |
| "STR" is shown on the display. | The dishwasher door has been opened while a program is in progress. | If you want the dishwashing program to continue, press the flashing program button and close the door within five seconds. (For Self Clean, press the associated option buttons.) If you want to cancel the dishwashing program, press and hold the main power switch until the display turns off. |
| The Heavy program has been run with the Sanitize option selected, but "End" is not shown on the display and the Sanitize option button does not light when the program has finished. | In order to meet the requirements of the NSF/ANSI 184 standard, the door must not be opened while the Heavy program is running with the Sanitize option selected. | Restart the dishwasher if the program must be run in compliance with the NSF/ANSI 184 standard. |
| | In order to meet the requirements of the NSF/ANSI 184 standard, the power must not be cut while the Heavy program is running with the Sanitize option selected. | Restart the dishwasher if the program must be run in compliance with the NSF/ANSI 184 standard. |
| | The Heavy program has been run with the Sanitize option selected but has not reached a sufficiently high temperature to meet the requirements of the NSF/ANSI 184 standard. | Restart the dishwasher if the program must be run in compliance with the NSF/ANSI 184 standard. |

| Problem | Possible causes | Action |
|--|---|--|
| Water remains in the dishwasher above the filters. | The filters are blocked. | Clean the coarse and fine filters. |
| | The filters are not fitted correctly. | Check that the filter handle is locked in the stop position. |
| | Debris in the drain pump. | Clean the drain pump. See the chapter Care and maintenance instructions. |
| | Drain pump stop missing. | Check that the colored stop on the right in the bottom drain is in place. See the chapter Care and maintenance instructions. |
| | Kink in drain hose. | Check that the hose is free from kinks and sharp bends. |
| | Blocked drain hose. | Loosen the drain hose from where it terminates. Check that no debris has clogged the hose. Is the cone-shaped part of the drain boot cut to the maximum size of the fitting where it attaches? |
| Bad odor in dishwasher. | Dirt around the seals and in corners. | Clean with dish brush and low foaming cleaner. |
| | Low temperature programs have been selected for a prolonged period. | Run a program with a higher temperature about once a month. Or select the self-cleaning program. See Self Clean in the chapter Using the dishwasher. |
| The dishes are not dry enough. | The Door Open option is not activated. | Activate the Door Open option. |
| | The dishwasher is not fully loaded. | Fully load the dishwasher. |
| | Rinse aid needs topping up or dosage is set too low. | Top up with rinse add or increase the rinse aid dosage. See the sections Before washing for the first time and Settings. |

Installation instructions

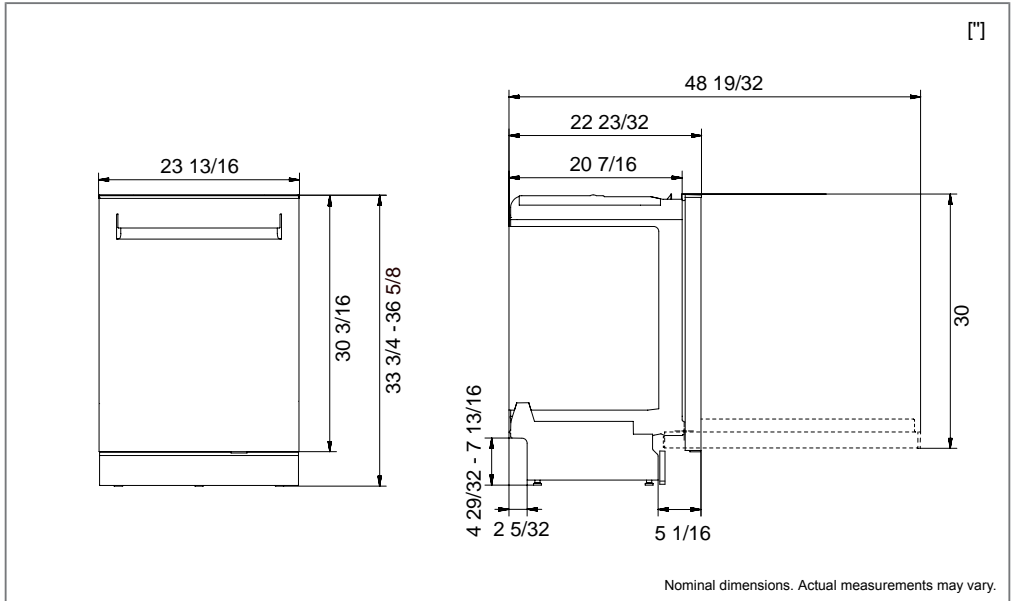

Important safety instructions

- Connections to electricity, water, and drainage must be performed by a qualified professional.
- Always follow applicable regulations for water, drainage, and electricity.
- Take care during installation! Wear protective gloves! There must always be two people!
- Place a drip tray on the floor beneath the dishwasher to prevent damage from any water leaks.
- Before screwing the dishwasher into place, test the dishwasher by running the Rinse program. Check that the dishwasher fills with water and drains. Also check that none of the connections leak.

Tools

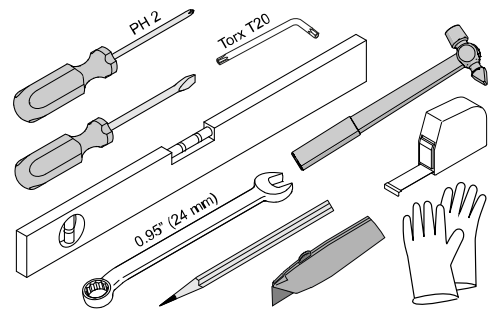

Transport protection for the door

Do not forget to remove the transport protection for the door when unpacking the dishwasher.

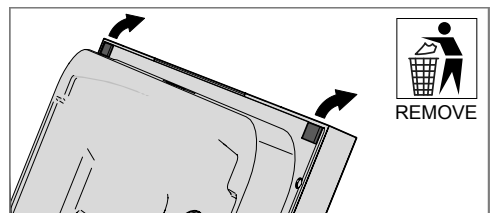

⚠ WARNING!

Turn off the water supply when installing the dishwasher!

The plug must be disconnected or power to the outlet turned off while installing the dishwasher!

Placing the dishwasher

The dishwasher is intended for installation under a countertop. The recess dimensions are illustrated.

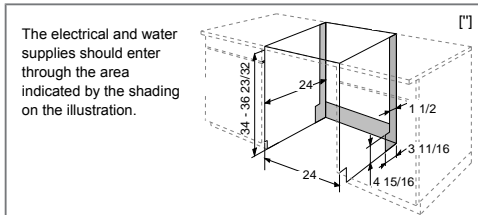

Use caution when the appliance is installed or removed to reduce the likelihood of damage to the power cord.

NOTE!

Framed cabinets require additional finished filler material behind the face frame for a proper installation. A minimum 3/2" (89 mm) finished return is required on all sides of the opening.

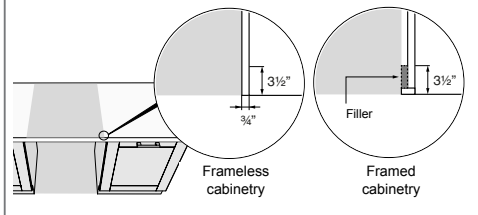

If the dishwasher is built-in, the surrounding furnishings must be resistant to any condensation from the dishwasher.

Fit the protective film

Fit the protective film (packed in the document bag) to the underside of the countertop. The protective film is to protect the countertop from moisture.

NOTE!

The surface to which the protective film is fitted must be clean and dry.

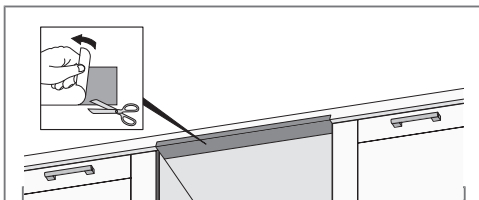

Adjust the height and slide the dishwasher into place

1. Start by measuring the height from the floor to the bottom edge of the countertop.
2. Measure the height from the floor to the top edge of the dishwasher.
3. Adjust the front feet by turning them clockwise to raise and counterclockwise to lower the dishwasher.

Lean the dishwasher forward a little and adjust the rear foot with the screw at the front of the dishwasher. Turn clockwise to lower or counterclockwise to raise.

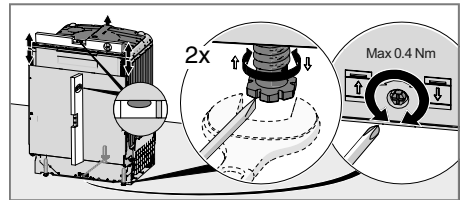

4. Verify there is an air gap of at least 0.1" (3 mm) between the underside of the countertop and the top edge of the dishwasher.
5. Slide the dishwasher into place.
 - Pull the drain and supply hoses through the opening as the dishwasher is slid into place.
 - Check that the hoses have no kinks or sharp bends, and check that there is nothing that can damage the hoses.

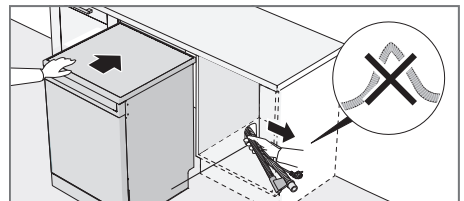

- Check that the machine is installed such that the door opens freely, otherwise door lock functionality may be disrupted.
6. Make any final adjustments to the front feet (the dishwasher may lean no more than 0.2" (5 mm)).

Drain connection

This dishwasher is suitable for installing in a raised recess (to attain an ergonomic working height). This means that the dishwasher can be placed so that the drain hose runs to a lower level than the bottom of the dishwasher, such as by routing it directly to a floor drain. The dishwasher is fitted with an integrated anti-siphon device to prevent the machine from being emptied of water during the wash cycle.

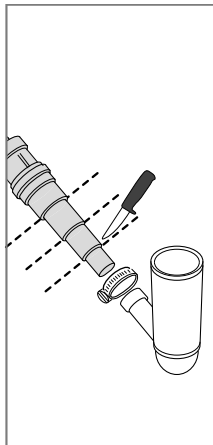
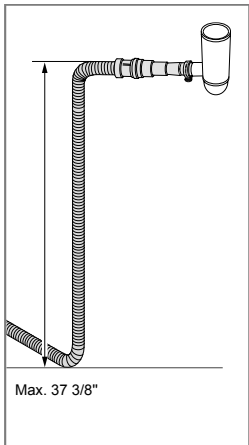
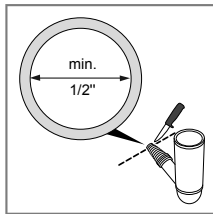
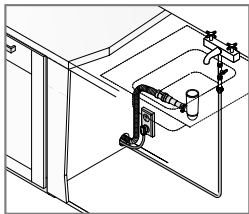

The drain hose can also be connected to a connection nipple on the sink unit's water trap. The connection nipple must have an internal diameter of at least 0.6" (14 mm).

The drain hose may be extended by a maximum of 118" (3 m) (the total length of the drain hose must not exceed 177" (4.5 m)). Any joints and connecting pipes must have an internal diameter of at least 0.6" (14 mm). However, the drain hose should ideally be replaced with a new hose without joints.

No part of the drain hose may be more than 37.4" (950 mm) above the bottom of the dishwasher.

Attach the drain hose with a hose clamp. Ensure that the drain hose has no kinks.

Connection to water supply

Use only the inlet hose supplied with the dishwasher. Do not re-use old or other spare hoses.

The supply pipe must be fitted with a water supply valve. The water supply valve must be easily accessible, so that the water can be shut off if the dishwasher has to be moved.

Once the installation is complete, turn on the water supply valve and allow the pressure to settle for a while. Check that all connections are watertight.

Water supply

The machine can be connected to either a cold or a hot (max. 160 °F (70 °C)) water supply. The water pressure should be 4.2-140 psi.

Connection to cold water supply

Connect the dishwasher to the cold water supply if the building is heated using oil, electricity, or gas.

Connection to hot water supply

Connect the dishwasher to the hot water supply (max. 160 °F (70 °C)) if the building is heated using an energy-efficient means such as district heating, solar power, or geothermal power. Choosing a hot water connection cuts dishwashing times and reduces the dishwasher's energy consumption.

NOTE!

Do not exceed the permitted water supply temperature. Certain materials used in some cookware cannot withstand strong heat. See Fragile dishes in the chapter Loading the dishwasher.

Electrical connection

Information about the electrical connection can be found on the serial number plate. This specification must match the electricity supply.

The power outlet for the appliance shall be installed in a cabinet or on a wall adjacent to the undercounter space in which the appliance is to be installed. If there is no power outlet available, contact a qualified electrician for a proper electrical installation. Do not use an extension cord for this appliance.

The access hole for the electrical supply must be round and smooth and no bigger than 1 1/2" in diameter. If the partition is metal, it needs to be covered with an edge protector.

Use caution when the appliance is installed or removed to reduce the likelihood of damage to the power cord.

Grounding instructions

This appliance must be grounded. In the event of a malfunction or breakdown, grounding will reduce the risk of electric shock by providing a path of least resistance for electric current. This appliance is equipped with a power cord fitted with an equipment grounding conductor and a grounding plug. The plug must be plugged into an appropriate power outlet that is installed and grounded in accordance with all local codes and ordinances.

⚠ WARNING!

Improper connection of the equipment grounding conductor can result in a risk of electric shock. Check with a qualified electrician or service representative if you are in doubt as to whether the appliance is properly grounded. Do not modify the plug provided with the appliance. If it does not fit the power outlet, have an appropriate power outlet installed by a qualified electrician.

Read the chapter Troubleshooting before contacting the service department. Provide the details on the serial number plate in all contact. Include the article number (1) and the serial number (2).

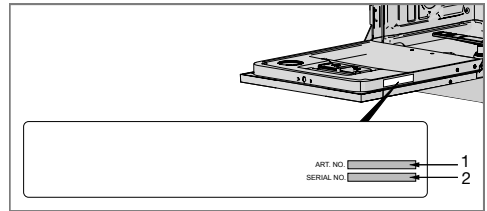

Screwing the dishwasher into place

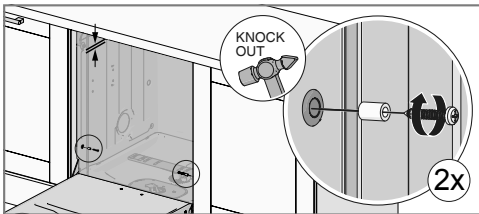
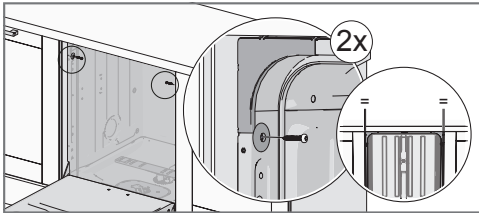

After fastening the machine, check that the front feet still touch the floor.

Dishwasher toe kick

The dishwasher is supplied with a toe kick.

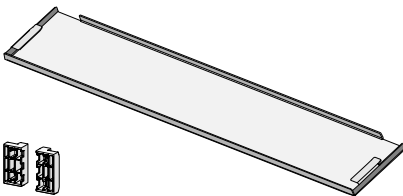

Fit the toe kick

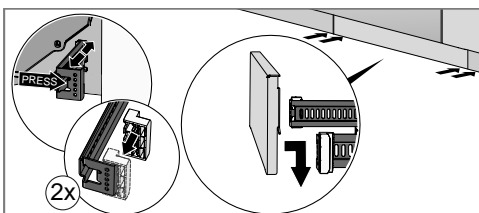

Technical data

Hisense

Model designation: HUI6220XCUS

Height: 33 3/4" - 36 5/8"

Width: 23 13/16"

Depth: 22 23/32"

Weight: 64 lb (29 kg) ¹⁾

Water pressure: 4.2–140 psi

Electrical connection: See serial number plate

Rated power: See serial number plate

1) *Weight can vary due to different specifications.*

08

