

ES-Y190507-1

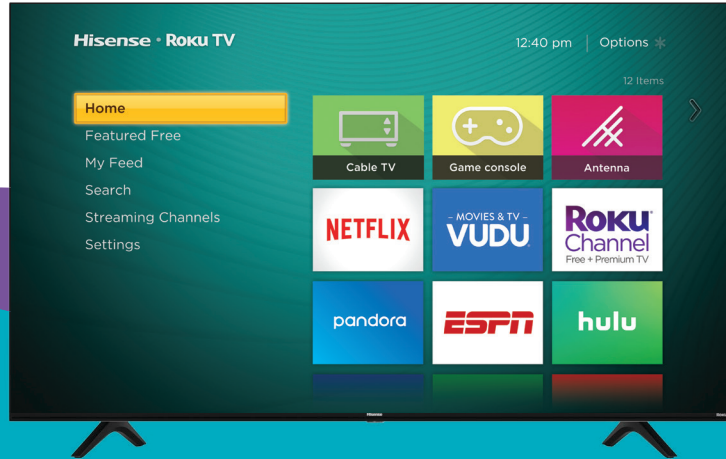

Hisense • Roku TV

55R6E3



Roku TV menu may vary and subject to change.

Quick Start Guide

Help Hisense and Roku improve the environment by reducing paper waste.
For detailed instructions and feature descriptions, access the full User
Manual online at www.hisense-usa.com/support.

© 2019 Hisense Company Ltd and Roku, Inc. All rights reserved. Hisense and the Hisense logo are registered trademarks of Hisense. ROKU, ROKU TV and the ROKU logo are trademarks and the property of Roku, Inc. Other channel logos, brand and product names are trademarks or registered trademarks of their respective holders.

All material in this Quick Start Guide is the property of Hisense Company Ltd. and Roku Inc. and its subsidiaries, and is protected under U.S. and International copyright and/or other intellectual property laws. Reproduction or transmission of the materials, in whole or in part, in any manner, electronic, print, or otherwise, without the prior written consent of Hisense Company Ltd. and Roku, Inc. is a violation of the rights of Hisense Company Ltd. and Roku, Inc. rights under the aforementioned laws.

No part of this publication may be stored, reproduced, transmitted or distributed, in whole or in part, in any manner, electronic or otherwise, whether or not for a charge or other or no consideration, without the prior written permission of Hisense Company Ltd. and Roku, Inc.

Requests for permission to store, reproduce, transmit or distribute materials may be made to the following address:

USA: Hisense USA Corporation
7310 McGinnis Ferry Road
Suwanee, GA 30024

Your easy way to endless entertainment

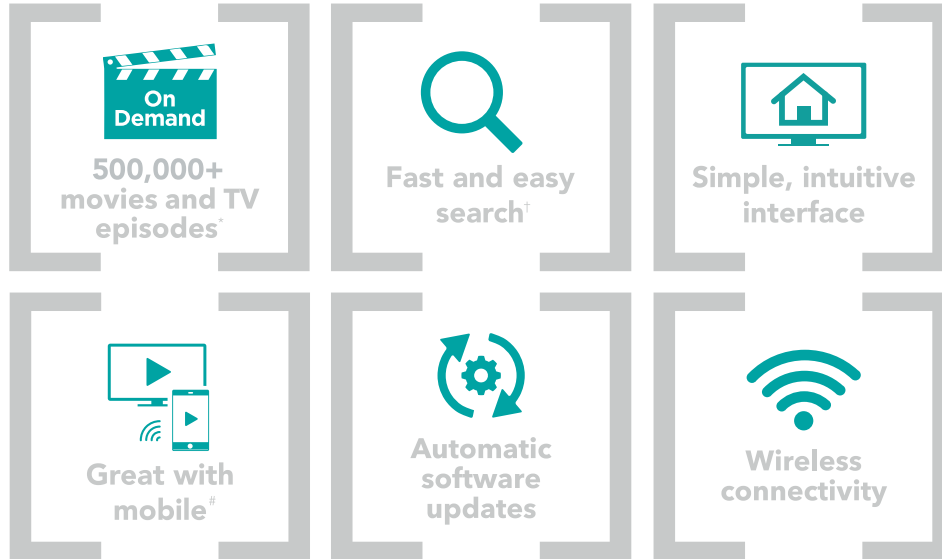

*Payment required for some channel content. Channels can change and vary by country.



† Roku search is for movies and TV shows and does not work with all channels.

‡ Limitations apply to the Roku mobile app. Please see support.roku.com for device compatibility information.

WELCOME TO THE HISENSE FAMILY!

Congratulations on the purchase of your new Hisense Roku TV! This Quick Start Guide will walk you through a few easy steps to set up your TV.

Because we value your business, we want to keep you in the know of 'all things Hisense'. Using your mobile phone, scan the Registration page QR code to register your TV. Depending on the make and model of your phone, you may need to download a QR code scanning app.

| Country | Customer Care Center | Hisense Support Page | REGISTER YOUR TV |
|---------|---|--|--|
| U.S.A | <ul style="list-style-type: none">• Phone: 1-888-935-8880• Hours of Operation: Monday - Friday: 9 AM to 9 PM EST Saturday - Sunday: 9 AM to 6 PM EST• Service Email: Service@hisense-usa.com | http://www.hisense-usa.com/support/  | http://www.hisense-usa.com/support/register  |

Disclaimer: This Quick Start Guide is intended as a general guideline to help you set up your Hisense Roku TV. Images throughout this document are for illustrative purposes only and may differ from the actual product.

Packaged contents

Your package in which you purchased your new TV contains the following items:

- TV
- Remote Control
- *Quick Start Guide (this document)*
- 2 legs that form the TV stand
- 2 AAA batteries
- *Important Safety Information and Warranty Card leaflet*
- 4 screws (M4×12)

IMPORTANT:

To prevent accidentally discarding items that came with your TV, be sure to **check ALL of the foam** in the carton box.

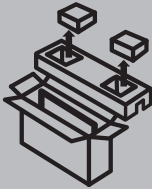

- Please check foam for accessories before discarding.
- Veuillez vérifier la mousse pour qu'il n'y ait pas d'accessoires avant de la jeter.
- Antes de desechar la espuma, asegúrese de retirar todos los accesorios.

Required tools and devices

- Wireless router (not included) for Internet connectivity
- Phillips screwdriver (not included) to secure the TV stand
- HDMI and other types of cables (not included) to connect external devices to the TV
- Wall mount bracket (not included) if you prefer to mount the TV to the wall

Buttons and ports on the Hisense Roku TV

TV Side View

Back View of the TV

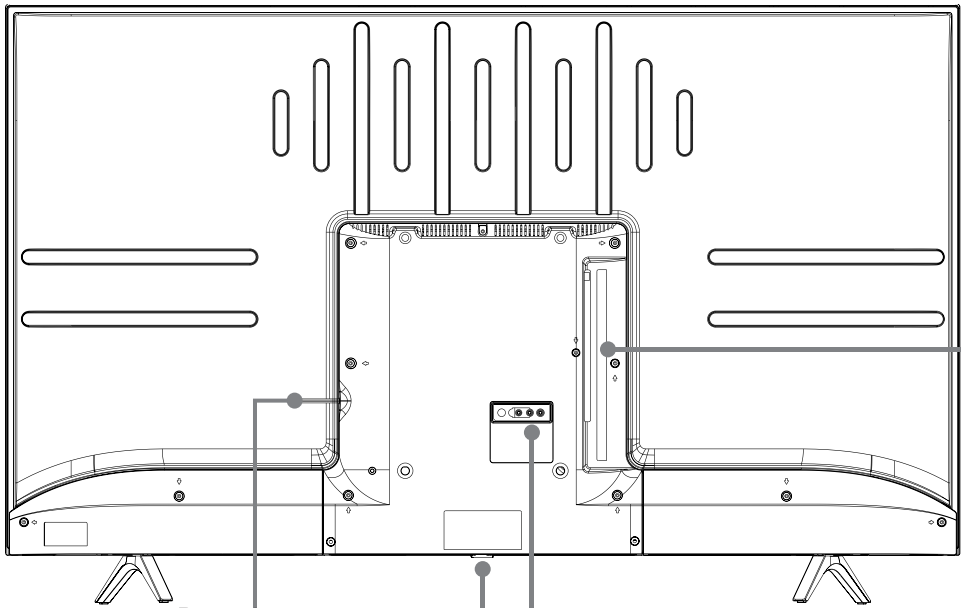

Power Input

⏻ / Input

TV Back View

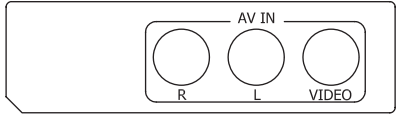

- ANT/CABLE
- HEADPHONE
- RESET
- LINE OUT
- HDMI 14k@60Hz
- ARC
- HDMI 21k@80Hz
- HDMI 34k@80Hz
- USB
- DIGITAL AUDIO OUT
- LAN

STEP 1. Attach the TV stand or wall mount bracket (not included)

Attach the TV Stand

CAUTION:

- Be sure to disconnect the A/C power cord before installing a stand or Wall-Mount brackets.
- The LED display is very fragile and must be protected at all times when installing the legs that form the stand. Be sure to protect the TV screen from getting scratched or damaged by any hard objects. In addition, DO NOT exert pressure on the front of the TV at any time because it could crack.

To attach the left and right leg that forms the stand:

1. Carefully place your TV face down on a soft, flat surface to prevent the TV from being damaged or the screen from getting scratched.
2. Remove the 2 legs from the foam and then insert the stands into the bottom slots of the TV.
3. Use the screws that came inside the carton with your TV to secure each leg tightly.

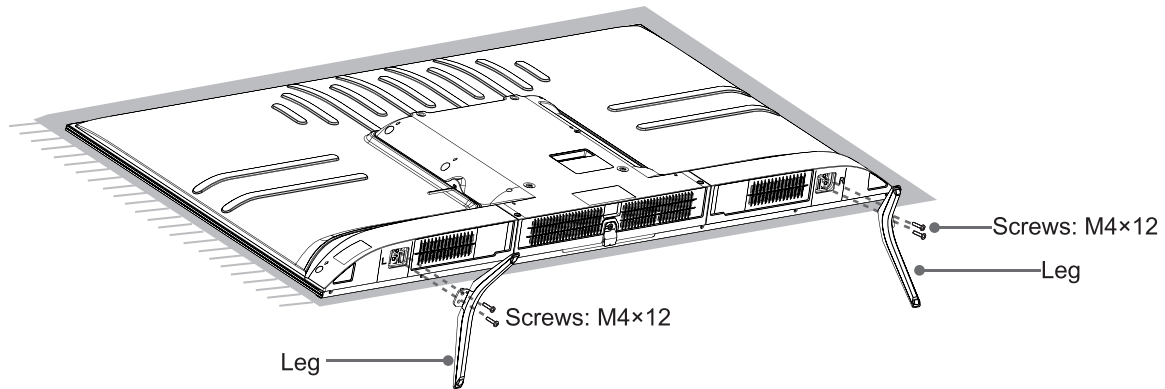

Attach the Wall Mount Bracket (not included)

Before you begin the third-party manufacturer instructions, be sure to do the following things:

1. Place the TV face down on a flat, clean, safe and cushioned surface.
2. Remove the TV stand if you already attached it.
3. Place the spacers (not included) in the corresponding bracket holes.

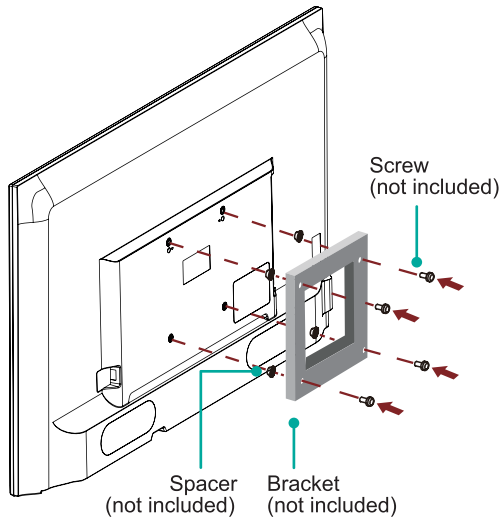

CAUTION:

- When you attach the mount, be sure to use the spacers (provided by the third-party manufacturer) between the TV and the bracket.

- To prevent internal damage to the TV and ensure it is mounted securely, be sure to use fixing screws (not provided) that are 8.0 - 10.0 mm in length when measured from the attaching surface of the mounting hook.

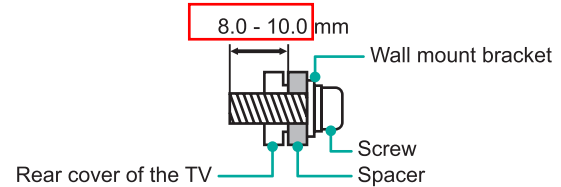

| | |
|-----------------------------|-----------|
| Wall mount hole pattern(mm) | 200 × 300 |
| Wall mount screw size (mm) | M6 |













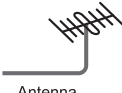
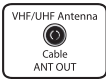





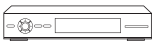



Follow instructions provided with the Wall mount bracket.

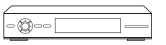







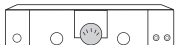
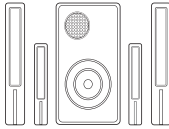

- If you have additional questions, please contact the wall-mount manufacturer or the retailer from which you purchased the TV.
- The selected screws are 8.0 - 10.0 mm in length when measured from the attaching surface of the rear cover.

NOTE: The diameter and length of the screws differ depending on the wall mount bracket model.

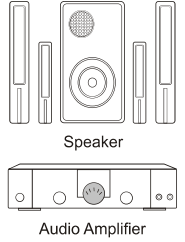
STEP 2. Connect devices to your TV

Check to ensure that you have selected the right cables for the ports and that they are connected securely. Loose connections can affect the quality of the picture image and color. (Cables and External Equipment not included.)

| TV label | | Port | Cable | External Equipment | Brief Description |
|-------------------|-------|---|---|--|---|
| ANT/CABLE | |  |  |  Antenna  VHF/UHF Antenna Cable ANT OUT | Connect an outdoor or indoor antenna. |
| HDMI | |  |  |  VCR  DVD Player/Recorder  Video Camera  Set-top Box  Satellite Receiver  Satellite antenna cable | Connect a High Speed HDMI® Cable from an external device. |
| AV IN | VIDEO |  |  Yellow |  Video Camera  Set-top Box  Satellite Receiver  Satellite antenna cable | Connect a composite video cable and left-right audio cables from an external AV device. |
| | L |  |  White | | |
| | R |  |  Red | | |
| DIGITAL AUDIO OUT | |  |  |  Audio Amplifier  Speaker | Connect a digital audio cable from an external digital audio system. |

| TV label | Port | Cable | External Equipment | Brief Description |
|--|---|---|--|---|
|  HEADPHONE |  |  | | Connect headphone (sold separately) for audio out of the TV. |
| LINE OUT |  |  |  | Connect an audio adapter (not provided) from an external analog audio system. |
| USB |  |  | | Connect a USB memory stick to enjoy its photos, music, and movies, or to enable Live TV Pause. Live TV Pause is only available on the Antenna input of your Roku TV and requires a dedicated USB 2.0 compatible flash drive with at least 16GB of storage. Live TV Pause requires connecting to the Roku service. |
| RESET |  | Restart or factory reset your TV. | | |
| LAN |  |  |  | Connect an Ethernet cable to access a network or the Internet. The TV also has a wireless connectivity feature. |

Buttons on your TV remote

The TV remote should feel right at home in your hand. We designed it to be incredibly intuitive for watching TV and navigating on-screen menus.

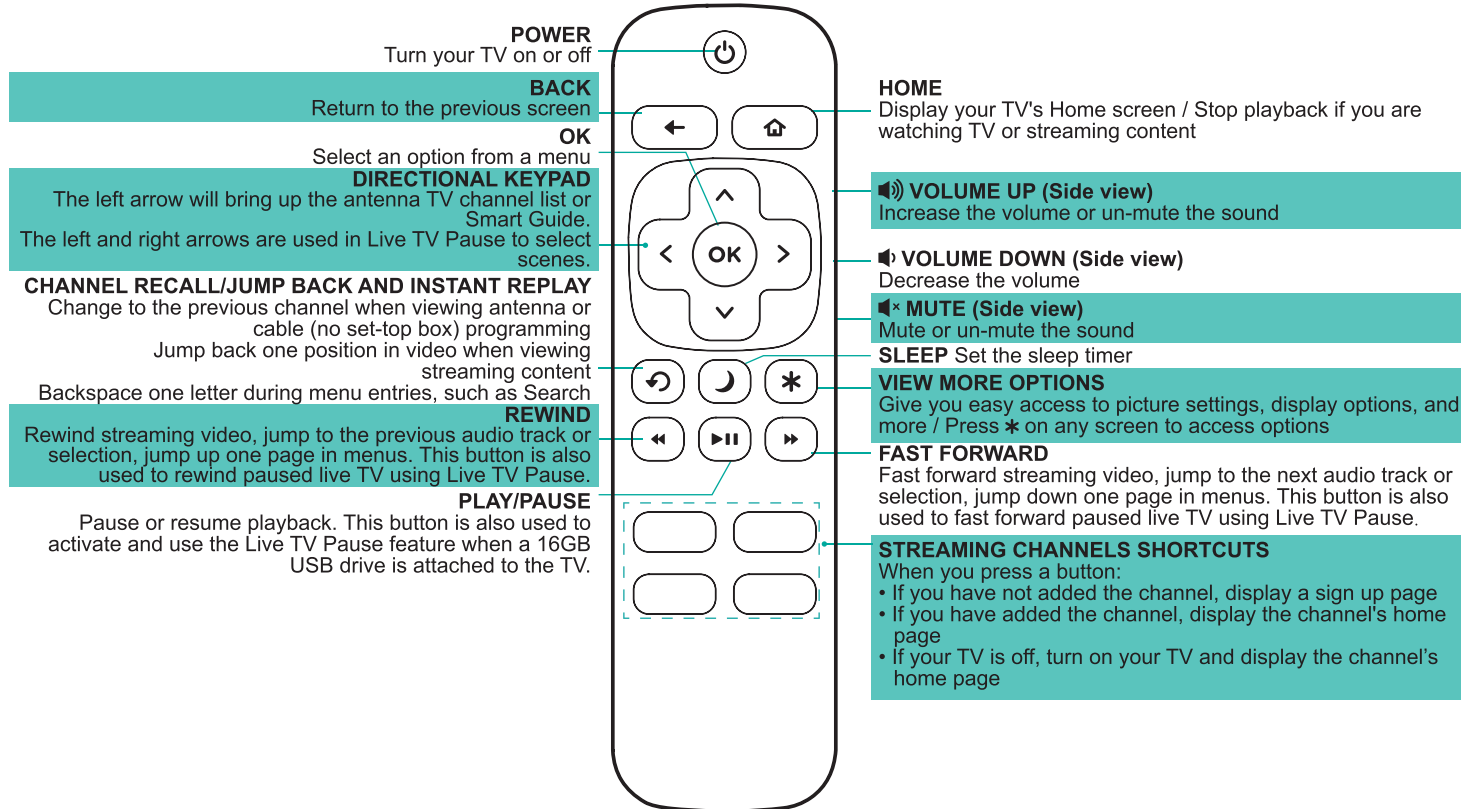

Disclaimer: Remotes may vary.

STEP 3. Begin using your remote

Power up your TV remote by inserting the included batteries.

CAUTION

- Dispose of the batteries in a designated disposal area. Do not throw them into a fire.
- Remove old batteries immediately to prevent them from leaking into the battery compartment.
- If you do not intend to use the remote control for a long time, remove the batteries.
- Battery chemicals can cause a rash. If the batteries leak, clean the battery compartment. If chemicals touch your skin, wash it immediately.
- Do not mix old and new batteries.
- Do not mix alkaline, standard (carbon-zinc) or rechargeable (for example, NiCd or NiMH) batteries.
- If your remote gets warm/hot during use, discontinue use and contact customer support immediately at www.hisense-usa.com/support.

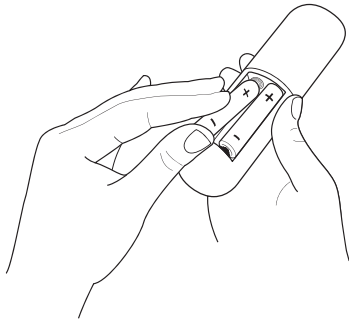

Using Your Cable Set-top Box or Satellite Receiver Remote as a 'Universal' Remote.

If you prefer to use your Cable Set-top Box or Satellite Receiver Remote as a 'Universal Remote', please refer to the manual that your cable or satellite service provided. It will include instructions on how to program their remote to your television. You can find codes that work with your Hisense Roku TV and the most common cable and satellite provider's universal remote control at www.roku.com/universalremote.

Turn on the TV

Connect the power cord to the power outlet.

Press the **Power**  button on the remote to turn on the TV. A startup screen appears that displays the **Hisense • Roku TV** logo.

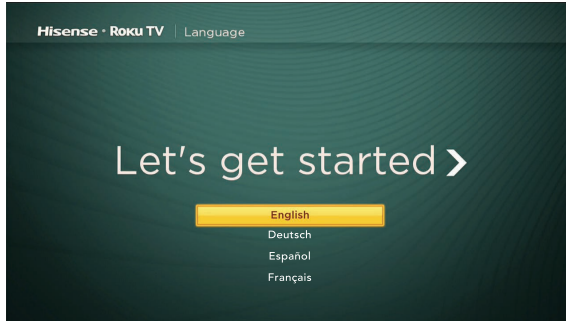

Choose **Set up for home use** to access all TV features and maximize Eco Save.

NOTE: Only retailers that need to set up the TV for display should select **Set up for store use**.

Hisense Roku TV Text to Speech Functionalities

Text-to-Speech and Video Description functionalities on the TV

Text-to-Speech (TTS) and Video Description can help you to navigate the menus on the screen and hear an audio description of relevant programs. Text-to-Speech can convert written text into voice text to help visually impaired people listen to the information they are unable to read. In addition, the Video Description has an audio narration added to certain programs that will describe the main visual elements which visually impaired users may not be able to see.

Follow the steps below to enable the functions:

1. Press the **Home** button to access the **Menu**.
2. Next, select **Settings** to enter the Settings Menu.
3. Select **Accessibility > Audio Guide** to turn the Audio Guide **'On'** or **'Off'**.

When the Audio Guide is turned 'On', then the contents of each menu displayed can be broadcasted out and you can hear the introduction of relevant programs.

<https://www.hisense-usa.com/hisense-roku-tv-text-to-speech-functionalities>



Connect your TV to the Internet to access thousands of streaming channels like Netflix & YouTube.

Make any night a movie night

Access more than 500,000* movies and TV episodes across major streaming services like Netflix, Hulu, Prime Video, VUDU and more. Choose from free, rental, and subscription services.

Stream sports on the big screen

Choose from over 140 sports channels like ESPN, FOX Sports Go, NBA, NFL, MLB, WWE, CBS Sports, and more.

Explore loads of free channels and free trials**

Your Roku TV has hundreds of popular free channels like The Roku Channel, CBS News, PBS, The CW and more. The Roku Channel features hundreds of Hollywood hits, all free and available to watch whenever you want. From comedies, to award-winners, to cult classics and more, No fees. And no login required.

**Payment required for some channel content. Channels can change and vary by country.*

***Cancel before the end of the free trial periods to avoid reoccurring monthly subscription fees. Credit card may be required. Free trials may only be available to new subscribers and other eligibility restrictions may apply.*



Explore your passions

Your Roku TV offers hundreds of streaming channels to fuel your passions – including fitness, kids & family, cooking, sports, religion, travel, International programming and more.

4K Spotlight

The Roku 4K UHD Spotlight channel features many movies and TV shows available in 4K UHD resolution from streaming services such as Netflix, Prime Video, VUDU, and more.

STEP 4. Complete the guided setup

Connect your Hisense Roku TV to your home network:

1. **Sign in to your wireless network.** Your TV will automatically detect wireless networks in your area. Have your network name and password handy and follow the easy on-screen instructions.
2. **Sign in to your wired network.** Your TV is currently not connected to a wired network. To set up a wired connection: Plug an Ethernet cable into your TV. Select 'Connect to wired network'.
3. **Activate your Roku account.** From your smartphone, tablet, or computer, go to www.roku.com/link and enter the code that is displayed on your TV screen. Roku accounts are free, and while a valid credit card number is not required to create your account, providing your credit card information makes renting and purchasing entertainment from the Roku Channel Store fast and convenient.

NOTE: ROKU does not charge for activation support - beware of scams.

4. **IMPORTANT:** Make sure you type roku.com/link into the browser being careful not to misspell or add extra characters. Typing this incorrectly may take you to fraudulent websites.

If you are not ready to connect your TV to a wireless or wired network, you can still use it to view live broadcast channels through your antenna, Set Top Box (STB) or Satellite.

Complete the rest of the on-screen prompts and setup is done. Congratulations!

NOTE: Once you're connected, your TV will automatically update with the latest software—plus you can start streaming the entertainment you know and love. Unlike other TVs, your new **Hisense Roku TV** automatically receives regular software updates in the background when it's connected to the Internet. This allows it to give you a better experience. For more information on setting up and using your Roku TV features, go to <http://go.roku.com/tvmanual>.

All software, applications, services and content accessible through the Television belong to providers who are not controlled by or affiliated with Hisense, are protected by copyright, patent, trademark and/or other intellectual property laws and are the sole property of their respective owners. Software, applications, services and content accessible through the Television are at the sole discretion and control of such providers and are completely outside Hisense's control. These services and/or content may be unavailable, discontinued or suspended by such providers, temporarily or permanently, at any time, without liability and without notice to you. HISENSE AND ROKU EXPRESSLY DISCLAIM ANY AND ALL RESPONSIBILITY FOR THE AVAILABILITY, CONTINUITY OF SERVICE, OR THE CONTENT PROVIDED BY ANY OR ALL SUCH PROVIDERS.

STEP 5. Personalize your Home screen

Easily switch between streaming channels and inputs.

The **Home** screen menu lets you access a ton of streaming entertainment, search for streaming movies and TV shows and change your settings.

The grid of tiles on the right lets you visually choose among your favorite streaming channels and the inputs where you have attached devices such as a DVR, game console, antenna, or set top box.

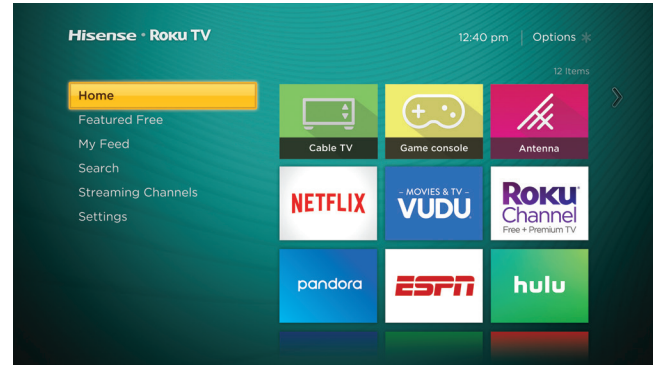

You can easily rearrange the order of the tiles on the Home screen to suit your viewing preferences. Highlight the tile you wish to move and press the * button on your Roku TV remote.



Step 6. Optional

Watching local broadcast TV? How do you scan for channels?

If you connected your TV to an antenna or cable wall jack (no box):

- 1) When the setup wizard is complete, select the ANTENNA icon  from the home screen.
- 2) Follow the on-screen instructions.
- 3) Whenever you want to watch local broadcast TV, select ANTENNA icon .
- 4) Connect a USB memory stick to enjoy photos, music, and movies, or to enable Live TV Pause. Live TV Pause is only available on the Antenna input of your Roku TV and requires a dedicated USB 2.0 compatible flash drive with at least 16 GB of storage.

Product specifications



| MODEL NAME | | 55R6E3 |
|----------------------------------|---------------------------------|---|
| Dimension (W x H x D) | Without Stand | 48.4×28.0×3.4 inches (1230×712×86 mm) |
| | With Stand | 48.4×30.4×9.2 inches (1230×772×234 mm) |
| Weight | Without Stand | 27.1 lbs (12.3 kg) |
| | With Stand | 27.8 lbs (12.6 kg) |
| DISPLAY | | |
| Active Screen Size (Diagonal) | 54.6 inches | |
| Screen Resolution | 3840×2160 | |
| Panel Selected | Ultra High Definition backlight | |
| POWER | | |
| Power Supply | AC 120V, 60Hz | |
| Standby Consumption | Less than 0.5W | |
| Audio Power | 8W + 8W | |

Product specifications (continued)

| CHANNELS & SIGNALING | |
|--------------------------|---|
| Receiving Channels | VHF: 2 - 13, UHF: 14 - 69, CATV: 1 - 125 Digital Terrestrial Broadcast (8VSB): 2 - 69 Digital cable (64/256 QAM): 1 - 135 |
| Tuner Type | Frequency synthesized |
| Receiving System | Analog: NTSC Digital: ATSC/QAM |
| HDMI Input | RGB/60Hz (640×480, 800×600, 1024×768, 1280×1024, 1360×768, 1440×900, 1680×1050, 1920×1080, 3840×2160) YUV/60Hz (480i, 480p, 720p, 1080i, 1080p, 2160p) |
| OTHER FEATURES | |
| Parental Control | Yes |
| HD Supported Definitions | 480i, 480p, 720p, 1080i, 1080p, 2160p |
| Sleep Timer | Yes |
| Wireless Built In | Yes |
| Environmental Conditions | Temperature: 41°F - 95°F (5°C - 35°C) Humidity: 20% - 80% RH Atmospheric pressure: 86 kPa - 106 kPa |
| Storage Temperature | 5°F to 113°F (-15°C to 45°C) |
| Storage Humidity | 10% to 70%, non-condensing |

Quick problem-solving tips

When you experience an issue with your TV, turn it off and on again. If this does not resolve the problem, then refer to the tips below. If the problem is still not resolved, then contact us at one of the phone numbers on Page 2.

| SOUND OR PICTURE ISSUES | POSSIBLE SOLUTIONS |
|--|--|
| You do not see a picture when turning on the TV | <ul style="list-style-type: none">• Check if the LED light is on. If it is, then there is power to the TV.• The TV may be in Standby mode. Press the Power  button on the remote control to activate the unit from Standby.• Check if the power cord is plugged into an active electrical outlet. |
| You have connected an external source to your TV but can not find it on the Home screen | <ul style="list-style-type: none">• Make sure your external source is turned on.• Check to see if the correct input tile is selected on the Home screen for the external source you want to view.• Check to see if the external source device connection is snug and fully inserted into the TV port. |
| When you turn on your TV, there is a delay for a few seconds before the picture appears | <ul style="list-style-type: none">• This is normal. If you have already set up your TV, it is initializing and searching for previous setting information. |
| You see a normal picture but do not hear any sound | <ul style="list-style-type: none">• Check that volume is turned up.• Check if “Mute” mode is ON. Turn off mute by pressing the Mute  button again, or pressing volume up. |
| You hear sound but picture color is faded or in black and white | <ul style="list-style-type: none">• Check that the Color value is set to 50 or greater.• Check the color on another channel or input tile. |
| Your sound or picture is distorted or appears wavy | <ul style="list-style-type: none">• Turn off and/or remove any electrical appliance that may be nearby the TV panel.• Insert the power plug of the TV set into another power outlet. |

Quick problem-solving tips (continued)

| SOUND OR PICTURE ISSUES | POSSIBLE SOLUTIONS |
|--|--|
| Your sound or picture is blurry or cuts out | <ul style="list-style-type: none">• If you are using an external antenna, check the connections for a snug and tight fit.• Adjust or reposition the antenna placement. |
| You see horizontal/vertical stripes on the picture, or it is shaking | <ul style="list-style-type: none">• Turn off and/or remove any electrical appliance that may be nearby the TV panel.• Insert the TV power cord into another electrical outlet. |
| CONNECTIVITY ISSUES | POSSIBLE SOLUTIONS |
| You cannot connect to your wireless network | <ul style="list-style-type: none">• From the Roku TV home screen, press the Directional Keypad down arrow to Settings. Press OK on the Directional Keypad. Press OK to select Network. Press the bottom Directional Keypad arrow to Check Connection. Press OK to Check connection• For additional help, visit www.hisense-usa.com/support. |
| REMOTE CONTROL ISSUES | POSSIBLE SOLUTIONS |
| Your remote control is not responding to button presses | <ul style="list-style-type: none">• Check that the TV is still on.• Check that the batteries are good and are inserted properly.• Check that there are no obstacles between the remote control and the front of the TV.• Try moving closer to the TV. If the LED on the TV flashes when you press any of the buttons on the remote control, the issue is not with the remote control. |

Certification and Compliance

FCC Notice

This device has been tested and found to comply with the limits for a Class B digital device pursuant to Part 15 of the FCC Rules. These limits are designed to provide reasonable protection against harmful interference in a residential installation. This device generates, uses, and can radiate radio frequency energy and, if not installed and used in accordance with the instructions, may cause harmful interference to radio communications.

However, there is no guarantee that interference will not occur in a particular installation. If this device does cause harmful interference to radio or television reception, which can be determined by turning the device off and on, the user is encouraged to try to correct the interference by one or more of the following measures:

- Reorient or relocate the receiving antenna.
- Increase the separation between the device and receiver.
- Connect the device into an outlet on a circuit different from that to which the receiver is connected.
- Consult the dealer or an experienced radio/TV technician for help.

NOTE: The manufacturer is not responsible for any radio or TV interference caused by unauthorized modifications to this equipment. Such modifications could void the user's authority to operate the equipment.

The WiFi Module complies with FCC radiation exposure limits set forth for an uncontrolled environment. This device should be installed and operated with a minimum distance of 20 centimeters between the radiator and your body.

Declaration of Conformity

Trade Name: Hisense

Model: 55R6E3

Responsible Party: Hisense USA Corporation

Address: 7310 McGinnis Ferry Road, Suwanee, GA 30024

Telephone Number: 678-318-9060

This device complies with Part 15 of the FCC Rules. Operation is subject to the following two conditions: (1) this device may not cause harmful interference, and (2) this device must accept any interference received, including interference that may cause undesired operation.



Manufactured under license from Dolby Laboratories. Dolby, Dolby Audio, and the double-D symbol are trademarks of Dolby Laboratories.



For DTS patents, see <http://patents.dts.com>. Manufactured under license from DTS Licensing Limited. DTS, the Symbol, DTS and the Symbol together, and DTS Studio Sound are registered trademarks and/or trademarks of DTS, Inc. in the United States and/or other countries. © DTS, Inc. All Rights Reserved.



The terms HDMI and HDMI High-Definition Multimedia Interface, and the HDMI Logo are trademarks or registered trademarks of HDMI Licensing Administrator, Inc. in the United States and other countries.



©2019. All rights reserved. Hisense and the Hisense logo are registered trademarks of Hisense. Other brand and product names are registered trademarks of their respective owners.