

ES-A191339-1 C



Hisense



Help Hisense improve the environment by reducing paper waste.
For detailed instructions and feature descriptions, access the full User Manual for your TV online.
Before using the TV, please read this guide carefully and keep it for future reference.

Copyright statement

© 2019 Hisense Company Ltd. All Rights Reserved.

All material in this Quick Start Guide is the property of Hisense Company Ltd. and its subsidiaries, and is protected under the laws of US, CANADA, MEXICO and International copyright and/or other intellectual property laws. Reproduction or transmission of the materials, in whole or in part, in any manner, electronic, print, or otherwise, without the prior written consent of the Hisense Company Ltd. is a violation of Hisense Company Ltd. rights under the aforementioned laws.

No part of this publication may be stored, reproduced, transmitted or distributed, in whole or in part, in any manner, electronic or otherwise, whether or not for a charge or other or no consideration, without the prior written permission of Hisense Company Ltd.

Requests for permission to store, reproduce, transmit or distribute materials may be made to one of the following addresses:

USA:

Hisense USA Corporation
7310 McGinnis Ferry Road
Suwanee, GA 30024

CANADA:

Hisense Canada Co., Ltd,
2283 Argentia Road, Unit 16
Mississauga, ON, Canada, L5N 5Z2

MEXICO:

Hisense Mexico S. de R.L. de C.V.
Blvd. Miguel de Cervantes Saavedra No 301
Torre Norte Piso 2, Col. Ampliación Granada
Miguel Hidalgo, Ciudad de México, C.P. 11520

Hisense, and any and all other Hisense product names, logos, slogans or marks are registered trademarks of Hisense Company Ltd. and its subsidiaries. All other trademarks are the property of their respective holders.

Disclaimer

Subscriptions or other payments may be required to access content through some applications. Some or all of the included or downloaded application services in this Hisense device may not function depending on the Internet connection, local limitations of included applications or other reasons outside of Hisense's control. HISENSE EXPRESSLY DISCLAIMS RESPONSIBILITY FOR ANY APPLICATION SERVICE FROM FUNCTIONING AT ANY TIME, FOR CONTENT IN ANY APPLICATION SERVICE, FOR DISRUPTIONS OF SERVICE, LOCAL OR REGIONAL LIMITATIONS, WARRANTIES OF TITLE, NO INFRINGEMENT, AND FOR IMPLIED WARRANTIES OF MERCHANTABILITY OR FITNESS FOR A PARTICULAR PURPOSE. By purchasing this device, you accept such Disclaimer without any claim on Hisense at any time.

This Quick Setup Guide supports the following models:

40H3F 40H3F1 40H3000F 40H3050F 40H3070F 40F3000

40F3030 40F3050 40F3070 40F3090 40H3509

40H3F9 40H3F8 40H3F7 40H3F5







Table of Contents

- Register Your TV!..... 2
- Packaged Contents..... 3
- Buttons and Ports on the TV 4
- Attach the TV Stand or Wall Mount Bracket 5
- Connect Devices to your TV 7
- Buttons on your TV Remote..... 9
- Begin Using your Remote..... 10
- Power on the TV 11
- Complete the Setup Wizard..... 12
- Begin to Enjoy your TV..... 12
- Feature TV Text to Speech functionalities 13
- Product Specifications..... 14
- Quick Problem-Solving Tips 16
- Certification and Compliance 17

Register Your TV!

Congratulations on the purchase of your new TV! This Quick Setup Guide will walk you through a few easy steps to set up your TV. For detailed instructions, access the User Manual on the support pages listed below.

Because we value your business, we want to keep you in the know of 'all things Hisense'. Using your mobile phone, scan the Registration page QR code to register your TV. Depending on the make and model of your phone, you may need to download a QR code scanning app.

Country	Customer Care Center	Hisense Support Page	REGISTER YOUR TV
U.S.A	<ul style="list-style-type: none"> • Phone: 1-888-935-8880 • Hours of Operation: Monday - Friday: 9 AM to 9 PM EST Saturday - Sunday: 9 AM to 6 PM EST • Service Email: Service@hisense-usa.com 	http://www.hisense-usa.com/support/ 	https://www.hisense-usa.com/support/register 
CANADA	<ul style="list-style-type: none"> • Phone: 1-855-344-7367 • Hours of Operation: Monday - Friday: 8 AM to 8 PM EST • Service Email: canadasupport@hisense.com 	 http://www.hisense-canada.com/support/	 http://www.hisense-canada.com/support/productReg.asp
MEXICO	<ul style="list-style-type: none"> • Phone: 01-800-008 8880 • Hours of Operation: Monday - Friday 9:00-18:00 • Service Email: servicio@hisense.com.mx 	https://hisense.com.mx/support/  <p>*Scan to download user manual</p>	https://hisense.com.mx/product-registration/ 

Disclaimer: This Quick Setup Guide is intended as a general guideline to help you set up your TV. Images throughout this document are for illustrative purposes only and may differ from the actual product.

Packaged Contents

Your package in which you purchased your new TV contains the following items:

- TV
- Important Safety Information and Warranty Card
- 2 AAA batteries
- 4 screws (M4x25)
- Quick Setup Guide (this document)
- Remote Control
- A left and right leg that forms the TV stand

IMPORTANT:

To prevent accidentally discarding items that came with your TV, be sure to **check ALL of the foam** in the carton box.

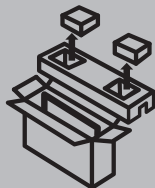

Please check foam for accessories before discarding.
Veuillez vérifier la mousse pour qu'il n'y ait pas d'accessoires avant de la jeter.
Antes de desechar la espuma, asegúrese de retirar todos los accesorios.

Required tools and devices

- Phillips screwdriver (not included) to secure the TV stand
- HDMI and other types of cables (not included) to connect external devices to the TV
- Wall mount bracket (not included) if you prefer to mount the TV to the wall

Buttons and Ports on the TV

TV Side View

Back View of the TV

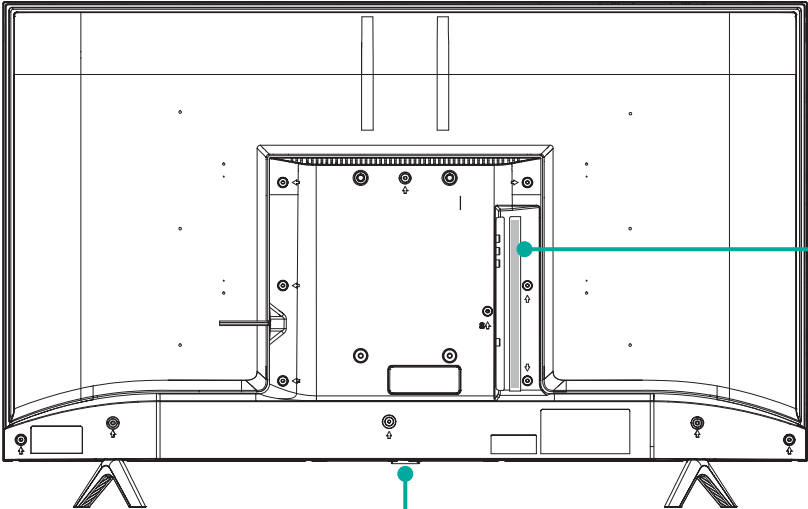

STANDBY / INPUT

- ANT/CABLE
- VIDEO
- AV IN
 - L
 - R
- HEADPHONE
- HDMI 3
- HDMI 2
- HDMI 1 (ARC)
- DIGITAL AUDIO OUT
- USB
- DC IN (3.5A/5V)

STEP 1. Attach the TV Stand or Wall Mount Bracket (not included)

Attach the TV Stand (For steps to attach the wall mount see page 6)

CAUTION:

- Be sure to disconnect the A/C power cord before installing a stand or Wall-Mount brackets.
- The LED display is very fragile and must be protected at all times when installing the legs that form the stand. Be sure to protect the TV screen from getting scratched or damaged by any hard objects. In addition, DO NOT exert pressure on the front of the TV at any time because it could crack.

To attach the left and right leg that forms the stand:

1. Carefully place your TV face down on a soft, flat surface to prevent damage to the TV or scratching to the screen.
2. Remove the 2 legs from the foam and then insert the legs into the bottom slots of the TV.
3. Use the screws that came inside the carton with your TV to secure each leg tightly.

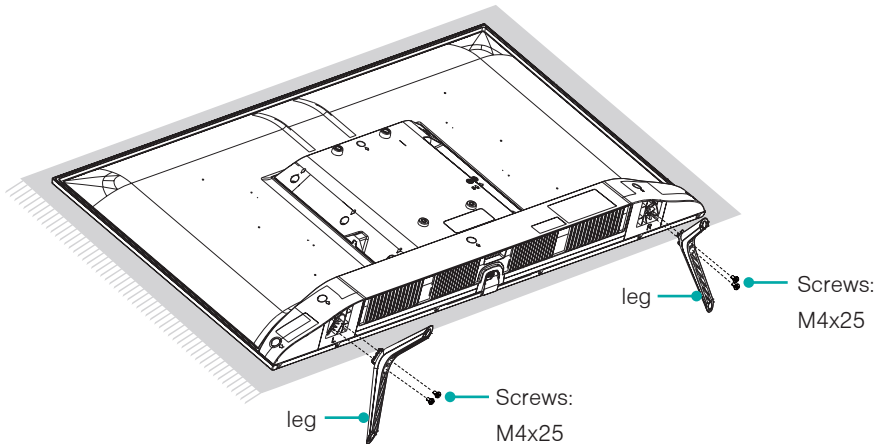

Attach the Wall Mount Bracket (not included)

Before you begin the third-party manufacturer instructions, be sure to do the following things:

1. Place the TV face down on a clean, safe and cushioned surface.
2. Remove the TV stand if you already attached it.
3. Place the spacers (not included) in the corresponding bracket holes.

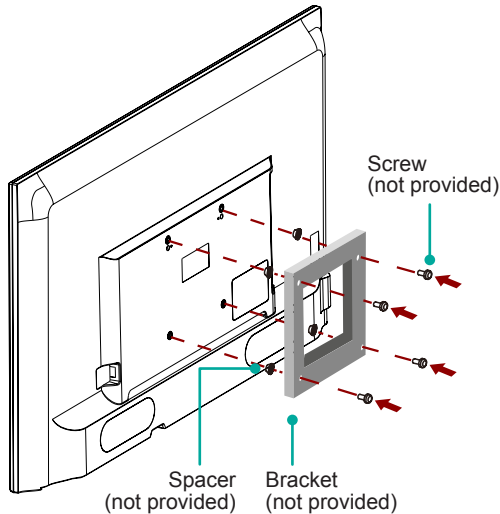

CAUTION:

- When you attach the mount, be sure to use the spacers (provided by the third-party manufacturer) between the TV and the bracket.

- To prevent internal damage to the TV and ensure it is mounted securely, be sure to use fixing screws (not provided) that are 8.0 - 10.0 mm in length when measured from the attaching surface of the mounting hook.

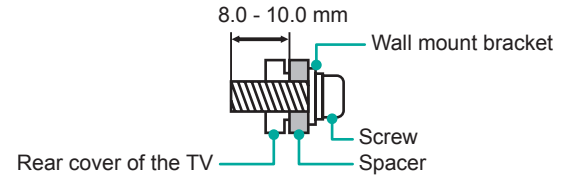

Wall mount hole pattern (mm)	100 x 200
Wall mount screw size (mm)	M6













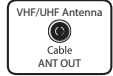





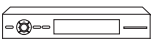





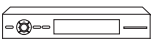

Follow instructions provided with the Wall mount bracket.

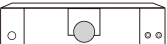

- To complete the installation, please contact the wall-mount manufacturer or the retailer from which you purchased the TV.
- The selected screws are 8.0 - 10.0 mm in length when measured from the attaching surface of the rear cover. The diameter and length of the screws differ depending on the Wall mount bracket model.

NOTE: The diameter and length of the screws differ depending on the wall mount bracket model.



STEP 2. Connect Devices to your TV



Check to ensure that you have selected the right cables for the ports and that they are connected securely. Loose connections can affect the quality of the picture image and color.

TV label		Port	Cable	External Equipment	Brief Description
ANT/CABLE				 Antenna  VHF/UHF Antenna Cable ANT OUT	Connect an outdoor VHF/UHF antenna.
HDMI				 VCR  DVD Player/Recorder  Video Camera  Set-top Box  Satellite Receiver  Satellite antenna cable	Connect a High Definition Multimedia Interface (HDMI) cable from an external device.
AV IN	VIDEO		 Yellow (Video)	 Video Camera  Set-top Box  Satellite Receiver  Satellite antenna cable	Connect a composite video cable and left-right audio cables from an external AV device.
	L		 White (L)		
	R		 Red (R)		
DIGITAL AUDIO OUT				 Digital Sound Bar  Audio Amplifier	Connect an optical cable from an external digital audio system.
USB					Connect a USB device for browsing photos, music and movies. The unit only recognizes a USB Memory Stick.

TV label	Port	Cable	External Equipment	Brief Description
HEADPHONE				Connect headphones to hear audio from the TV. Headphones with microphones are not supported.

Buttons on your TV Remote

BUTTON	DESCRIPTION
	Power on / off
INPUT	Change TV input source
MENU	The button for the Settings menu
Number	Enter Channels / Input numbers
—	Dash button / Select a digital sub-channel
CH LIST	Display the channel list
MUTE	Mute and restore sound
LAST	Go to the previous channel
+ VOL —	Volume (up/down)
+ CH —	Channel (up/down)
LIVE TV	Enter the Live TV
	D-pad (up/down/left/right navigation buttons) / Press Up display the Info menu
OK	Confirmation button/Display the channel list
BACK	Return to the previous place in the menu
EXIT	Exit the application
MEDIA	Enter the Media player

BUTTON	DESCRIPTION
MTS	Set the audio language (Multi Track Sound)
CC	Turn Closed Caption On/Off
NRT	Choose to leave the Video description feature On or Off (Narration)
FAV LIST / ADD/ERASE / FAV + / FAV -	Favorite program controlling buttons
	Media content control function buttons
PICTURE	Select picture mode button
SOUND	Select sound mode button
ASPECT	Zoom button
SLEEP	Sleep timer button
 (Red / Green / Yellow / Blue)	Special function buttons(Not available)

NOTE: The buttons are only for reference, actual remote may vary in appearance.

STEP 3. Begin Using your Remote

1. Slide the back cover to open the battery compartment of the remote control.

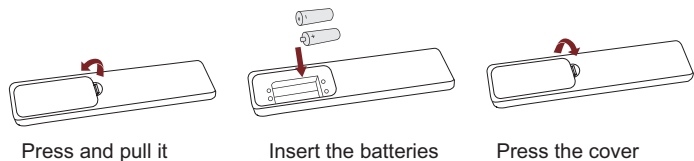

2. Insert two AAA size batteries. Make sure to match the (+) and (-) ends of the batteries with the (+) and (-) ends indicated in the battery compartment.
3. Replace the battery compartment cover.

Important Information about the remote and batteries:

- Discard batteries in a designated disposal area. Do not throw them into a fire.
- Remove old batteries immediately to prevent them from leaking into the battery compartment.
- If you do not intend to use the remote control for a long time, then remove the batteries.
- Battery chemicals can cause a rash. If the batteries leak, clean the battery compartment with a cloth. If chemicals touch your skin then wash it immediately.
- Do not mix old and new batteries.
- Do not mix alkaline, standard (carbon-zinc) or rechargeable (NiCd, NiMH, etc.) batteries.
- Do not continue using the remote if it gets warm or hot.

Call our Support Center immediately on the support website.

Remote Control Range Information

- The remote control can work at a distance of up to 26 feet in front of the TV set.
- It can work at a 30 degree horizontal or vertical angle.

Program Your Universal Cable or Satellite Remote Control to Operate Your New Television (only for USA)

If you would like to program your other household remote controls to your new television, please refer to the User's Manual supplied by your Cable or Satellite provider. The Cable or Satellite providers' User's Manuals should include instructions on how to program their remote to your television.

A list of codes for the most common Cable and Satellite providers are listed below. Use the code that is associated with your Cable or Satellite provider (if applicable).

DIRECTV.....0178, 10178, 10019, 10748, 11314, 11660, 11710, 11780, 12049, 10171, 11204, 11326, 11517, 11564, 11641, 11963, 12002, 12183

Time Warner Cable.....386, 0178, 10178, 400, 450, 461, 456, 0748, 1463, 0463, 10463

Comcast.....0178, 10178, 10463, 11463, 10748, 11314, 11660, 10171, 11204, 11326, 11517, 11641, 11780, 11785, 11892, 11963, 12002

Cox Communications.....0178, 10178, 1326, 1463

Dish Network.....505, 627, 538, 720, 659

If the code associated with your Cable or Satellite provider is not listed, does not work or you cannot locate the instructions to program your remote, call your local Cable or Satellite provider's customer service center.

If your Cable or Satellite provider does not have a code available, please contact us at one of the phone numbers on Page 2.

Using Your Cable Set-top Box or Satellite Receiver Remote as a 'Universal' Remote

If you prefer to use your Cable Set-top Box or Satellite Receiver Remote as a 'Universal Remote', then visit the Support page to view a list of the codes.

STEP 4. Power on the TV

Plug the power cord into a power outlet.

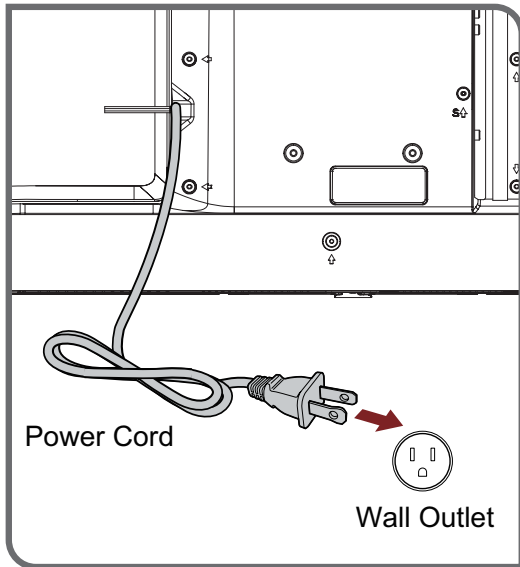

Press the **Power button** (⏻) on the remote to turn on the TV. A splash screen that shows the logo appears. Next, the Setup Wizard begins by prompting you to choose your **Language, Country,** and **Use Mode.**



STEP 5. Complete the Setup Wizard

After the splash screen that shows the logo appears,begin the Setup Wizard

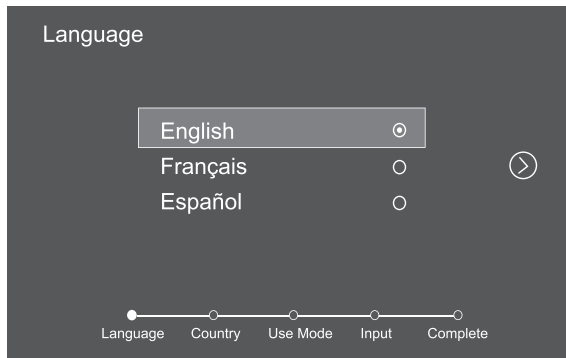

Screen	Task
Language	• Using the D-pad arrows of your remote,choose your language: English , Français or Español .
Country	• Using the D-pad arrows of your remote,choose your country: USA,Canada or Mexico
Use Mode	• Select your Mode Setting: Home Mode or Store Mode . • Note: 'Store mode' should only be selected by Retailers who plan to demonstrate the TV.

Screen	Task
Live TV Source	Select how you receive your TV channels. If you have a Satellite/Cable box,choose Yes, then choose from one of the following sources below and then move to the next screen. <ul style="list-style-type: none">• TV• AV• HDMI1• HDMI2• HDMI3 <p>TIP: You only need to scan for channels if your TV is connected to an Antenna.</p>

CONGRATULATIONS! You are done with setup.

Press the OK confirmation button on your remote if you are fine with the selections that appear on the screen. Otherwise,navigate to the back arrow on the screen to change your selection.

STEP 6. Begin to Enjoy your TV

Your TV is easy to use and brag-worthy!

Now that you've completed the Setup Wizard,the Home screen is your starting point for navigating the TV. Gone are the days where your TV only provides one way for you to be entertained. This showpiece provides you the convenience of watching a program on a live channel,accessing Video on Demand to watch a movie and many other entertainment options.

Enjoy your new TV!

Feature TV Text to Speech functionalities

Text-to-Speech (TTS) and Video Description can help you to navigate the menus on the screen and hear an audio description of relevant programs.

Text-to-Speech can convert written text into voice text to help visually impaired people listen to the information they are unable to read. In addition, the Video Description has an audio narration added to certain programs that will describe the main visual elements which visually impaired users may not be able to see.

Follow the steps below to enable the functions:

1. Press **MENU** to open the main menu.
2. Next, select **Accessibility** to enter the Accessibility Menu.
3. Select **Menu Audio** or **Video Description** to turn the Menu Audio or Video Description 'On' or 'Off'.

When Menu Audio is turned On, then the contents of each menu displayed can be broadcasted out.

When Video Description is turned On, then you can hear the introduction of relevant programs.

<https://www.hisense-usa.com/hisense-feature-tv-tts>



Product Specifications

Model Name		40H3F/40H3F1/40H3000F/40H3050F/40H3070F/40F3000/40F3030/40F3050/ 40F3070/40F3090/40H3509/40H3F9/40H3F8/40H3F7/40H3F5
Dimension (W x H x D)	Without Stand	35.6 x 20.4 x 3.2 inches (904 x 519 x 81.6 mm)
	With Stand	35.6 x 22.4 x 8.0 inches (904 x 569 x 204 mm)
Weight	Without Stand	12.8 lbs (5.8 kg)
	With Stand	13.0 lbs (5.9 kg)
Active Screen Size (Diagonal)		39.6 inches
Screen Resolution		1920 x 1080
Audio Power		7 W + 7 W
Power consumption		70 W
Power Supply		120 V ~ 60 Hz
Picture Quality		Screen resolution 1920 x 1080, FHD Upscaler
Ports		3 HDMI ports, 1 USB port, 1 Digital Audio Output, 1 RF Input, 1 Earphone Audio Output, 1 RCA Composite Video Input, 1 left/right Audio Input for Composite
Receiving Channels		VHF: 2 - 13, UHF: 14 - 69, CATV: 1 - 125 Digital Terrestrial Broadcast (8VSB): 2 - 69 Digital cable (64/256 QAM): 1 - 135
Turner Type		Frequency synthesized
Receiving systems		Analog: NTSC Digital: ATSC/QAM

Operating Temperature	5°C - 35°C(41°F - 95°F)
Operating Humidity	20% to 80% non-condensing
Storage Temperature	-15°C to 45°C(5°F to 113°F)
Storage Humidity	10%to 70%,non-condensing

Disclaimer: All products, product specifications, and data are subject to change without notice to improve reliability, function, design or other aspects.

Quick Problem-Solving Tips

When you experience an issue with your TV, turn it off and on again. If this does not resolve the problem, then refer to the tips below. If the problem is still not resolved, then contact us at one of the phone numbers on Page 2.

ISSUES	POSSIBLE SOLUTIONS
No sound or picture	<ul style="list-style-type: none"> • Check if the power cord is plugged into a powered AC outlet. • Press the Power button on the remote control to activate the unit from 'Standby' mode. • Check to see if the LED light is on or not. If it is, then the TV is receiving power.
I have connected an external source to my TV and I get no picture and/or sound.	<ul style="list-style-type: none"> • Check for the correct output connection on the external source and for the correct input connection on the TV. • Make sure you have made the correct selection for the input mode for the incoming signal.
When I turn on my TV, there is a delay for a few seconds before the picture appears. Is this normal?	<ul style="list-style-type: none"> • Yes, this is normal. The TV is initializing and searching for previous setting information.
The picture is normal but there is no sound	<ul style="list-style-type: none"> • Check the volume settings. • Check if 'Mute' mode is set to On.
Sound but no picture or black and white picture	<ul style="list-style-type: none"> • If the picture is black and white, unplug the TV from the AC outlet and replug it after 60 seconds. • Check that the Color is set to 50 or higher. • Try different TV channels.
The sound and/or picture is distorted or appears wavy	<ul style="list-style-type: none"> • An electric appliance may be affecting the TV. Turn off any appliances that are nearby and move it farther away from the TV. • Insert the power plug of the TV set into another power outlet.
The sound and picture is blurry or cuts out	<ul style="list-style-type: none"> • If using an external antenna, check the direction, position and connection of the antenna. • Adjust the direction of your antenna or reset or fine tune the channel.
A horizontal or vertical stripe appears on the picture and/or the picture is shaking	<ul style="list-style-type: none"> • Check if there is an appliance or electric tool nearby that is causing interference.
The plastic cabinet makes a "clicking" type of sound	<ul style="list-style-type: none"> • The 'click' sound can occur when the temperature of the television changes. This change causes the television cabinet to expand or contract, which makes the sound. This is normal and the TV is OK.
The remote control does not work	<ul style="list-style-type: none"> • Confirm that TV still has power and is operational. • Change the batteries in the remote control. • Check if the batteries are correctly installed.

Certification and Compliance

FCC Notice

This device has been tested and found to comply with the limits for a Class B digital device pursuant to Part 15 of the FCC Rules. These limits are designed to provide reasonable protection against harmful interference in a residential installation. This device generates,uses,and can radiate radio frequency energy and, if not installed and used in accordance with instructions, may cause harmful interference to radio communications.

However, there is no guarantee that interference will not occur in a particular installation. If this device does cause harmful interference to radio or television reception,which can be determined by turning the device off and on, the user is encouraged to try to correct the interference by one or more of the following measures:

- Reorient or relocate the receiving antenna.
- Increase the separation between the device and receiver.
- Connect the device into an outlet on a circuit different from that to which the receiver is connected.
- Consult the dealer or an experienced radio/TV technician for help.

NOTE: The manufacturer is not responsible for any radio or TV interference caused by unauthorized modifications to this equipment. Such modifications could void the user's authority to operate the equipment.

Declaration of Conformity

Trade Name: HISENSE

Model: 40H3F/40H3F1/40H3000F/40H3050F/40H3070F/40F3000/40F3030/40F3050/40F3070/40F3090/40H3509/40H3F9/40H3F8/40H3F7/40H3F5

Responsible Party: Hisense USA Corporation

Address: 7310 McGinnis Ferry Road,Suwanee,GA 30024

Telephone Number: 678-318-9060

This device complies with Part 15 of the FCC Rules. Operation is subject to the following two conditions: (1) this device may not cause harmful interference,and (2) this device must accept any interference received,including interference that may cause undesired operation.



Manufactured under license from Dolby Laboratories. Dolby, Dolby Audio, and the double-D symbol are trademarks of Dolby Laboratories.



The terms HDMI and HDMI High-Definition Multimedia Interface, and the HDMI Logo are trademarks or registered trademarks of HDMI Licensing Administrator, Inc. in the United States and other countries.



Environmental Protection

This mark indicates that this product should not be disposed together with other domestic garbage, to avoid damage to the environment or human health due to the disposal of uncontrolled waste. Recycle it responsibly for promoting the sustainable reuse of material resources. To return your used device, please use the return systems available in your location or contact the vendor where you purchased your product they could take this product for recycling and protection of the environment.

©2019. All rights reserved. Hisense and the Hisense logo are registered trademarks of Hisense. Other brand and product names are registered trademarks of their respective owners.